

BLOODY BRAZILIAN

Knife Fightin' Techniques



BY: UNCLE FESTER RICK "KAMAKAZE" HAKAYAMA
PEDRO "FAT" CAVALCANTI MAD ASE



Bloody Brazilian Knife Fightin' Techniques





Bloody Brazilian Knife Fightin' Techniques
by FESTERING PUBLICATIONS

Direct inquiries and/or orders to the above address
and visit my website www.unclefesterbooks.com.

All rights reserved. Except for use in a review, no portion
of this book may be reproduced in any form without the written
permission of the publisher. Neither the authors nor the
publisher assumes any responsibility for the use or misuse
of the information contained in this book.

Photos: Pedro Cavalcanti

Drawings: Ricardo Nakayama

Models: Ricardo Nakayama and Alexandre Cruz

Bloody Brazilian Knife Fightin' Techniques©2004 By Steve Preisler,
Bloody Brazilian Knife Fightin' Techniques©2004 By Festering
Publications

All Rights Reserved

Printed in USA

Published by:

Festering Publications

826 S. Baird Green Bay, WI 54301

Library of Congress Catalog Card Number 89-092677

ISBN 0-9701485-5-0

Bloody Brazilian Knife Fightin' Techniques
By Uncle Fester, Rick "Kamakaze" Nakayama,
Pedro "Fat" Cavalcanti and Mad Abe
Published by Festering Publications
826 S. Baird St. Green Bay,
WI 54301

Copyright©2004 by Festering Publications
Printed in the United States of America



Rick "*Kamikaze*" Nakayama
Pedro "*Fat*" Cavalcanti
Mad Abe (*J. R. R. Abrahão*)
Uncle Fester (*Steve Preisler*)
Foreword by Jim Benson



Bloody Brazilian Knife Fightin' Techniques



FESTERING
Publications





Foreword

Knife fighting is a subject that has been covered in many books, articles and videos over the years.

There are many different styles of this art and science developed in countries and among cultures around the world.

I am certainly no expert on this subject. Indeed, I don't consider myself an authority on knife fighting in any way. But I have been the victim of an attempted armed robbery in which I faced three assailants armed with a large butcher knife.

I have also studied Karate and other martial arts.

And in my nearly two decades as an editor of survival publications, I've seen quite a few texts from books and articles on knife fighting, along with numerous training video tapes on different martial arts styles employing techniques to defend against knife attacks.

Bloody Brazilian Knife Fightin' Techniques is unique among these, due to its comprehensive approach to the subject, and its eclectic method.

It's an interesting read and highly informative educational tool for anyone interested in defending themselves against armed or unarmed assailants.

There is in-depth discussion, accompanied by high-quality illustrations, of knife-fighting techniques, training for these, types of knives available for combat situations, and the mental preparations required to be able to react with the speed and effectiveness to stay alive amid the vicious actions of knife combat.

The book's authoritative content is due to the combined, accumulated knowledge of its four authors' long and varied training, studies and experience.

Knowledge is drawn from both from within Brazil, the main area of focus, and from other countries where knife fighting techniques have been studied.

"Mad Abe", as **J.R.R.Abrahão** is sometimes called, started Judo training when he was just 4 years old. He began Karate training at age 7. He has trained in several other martial arts and combat sports, including Chi Kung, Western-style boxing and Arnis. As a former intelligence officer for his country he has worked on high-risk assignments in home and abroad.

Master Rick "Kamikaze" Nakayama created and developed the "SOTAI System" of personal defense and knife fighting, an ad-



vanced and revolutionary method whose main characteristics are the efficiency and simplicity of the techniques and its emphasis on the safety of the practitioner.

“Fat Pedro” Cavalcante began Judo training when he was just 7 years old. He has also trained in Kendo, Occidental boxing and “Vale-Tudo.” His interests in knife fighting began when he served in a Brazilian Army paratrooper brigade. He has studied under Master Nakayama’s direct supervision and is today himself a qualified master instructor of the SOTAI System.

“Uncle Fester”, founder of UncleFester Books.com, was the first American student of the SOTAI System and is the publisher of this book.

This book is not for the squeamish or faint of heart. Its subject matter is deadly serious. Survival is not a sport or a game.

For those of us who have faced knife-wielding assailants, there is a defining moment, that split second in which you realize you are facing ghastly wounding or death and you **MUST** act and act decisively.

As is pointed out in the book, your mind-set in a knife fight is everything:

“Some [knife fighting] methods, undoubtedly, are more efficient than others but with any of them the most important element is the mental preparation.

There must be an internal change of the combatant, the development of an unflinching spirit when facing death, the final destiny of every human being...which so few of us are really prepared to meet.”

Having a good quality knife you can use to defend yourself, and having the capability of reacting effectively against a knife-wielding attacker provides a great deal of peace of mind, and self-assurance.

This book is a powerful resource to help you gain that peace of mind and self-assurance.

Jim Benson
Editor & Publisher
ModernSurvival.net
June 2004

Jim Benson is one of the foremost experts in Survival & Survivalism and surely the most seasoned publisher on this topic.

He is the former editor of the historic **“ASG - American Survival Guide”** and now, once again on the first line, he is publishing a Survival Magazine on the “last frontier”: the Internet.

See his virtual magazine **“Modern Survival”**, a heir to his tradition, at www.modernsurvival.net



Brazilian Knife Fighting

Why is it any different from the dozens of Knife Fighting methods out there?

Ah... if you asked this question, you don't know anything about the Brazilian way of life and the brutal reality of the streets there!

A former Portuguese colony, Brazil was run by a political élite since it was discovered in the 1500's. Although Brazilians have a love affair with firearms, they were always much too expensive for the common citizens.

Hence, Blades become the survival tools of choice.

Ruled by tyrants most the time, one of the most brutal rulers was Getulio Vargas, who created some of the most draconian Gun Laws in the World. Left with little else, Brazilian citizens resorted to Blades to defend themselves.

It was during the Vargas dictatorship that Brazil was involved in WW II, joining the Allies. Fighting in the European war theater, they became more feared for their Knife and Razor Blade skills than for any other fighting instrument at their disposal. When the German and Italian soldiers heard the screams of their unfortunate comrades who got caught by Brazilian Commandos, they surrendered - but demanded that the Knife-toothed soldiers be kept at bay!

With Vargas' death in the middle-50's, Brazil experienced a few years of democracy - but,

the tough Gun Laws became even tougher. It seems that Brazilian rulers fear armed citizens...

After just a few years, there was a brutal Military Coup D'Etat. The Military dictatorship lasted from 1964 through 1984, when a transition Government was placed in power pending the election of a President by the people - the first time in 40 years.

All during those Military dictatorship years, the Gun Laws became even tougher. The dirty-war against the communist guerrillas in the '70's provided the pretext needed to beat up on the common people still more. This gun control was ineffective in its stated aim of denying weaponry to the rebels, but it did make the already beleaguered law abiding populace even more defenseless.

When democracy became the ruling system again, things became even worse for the firearms-loving citizen. Much of the population is made up of people who Mohatma Gandhi described as "savages, hardly one step removed from the animal". With the crushing heel of the military removed, common and organized crime rose to unseen levels, and new laws against civilian ownership of firearms became the reality. With 170 million inhabitants, Brazil has less than 5 million firearms on the han-



ds of common citizens. Most of these guns are old rusty revolvers or derringers and nearly useless.

So how can Brazilian citizens survive in a Nation with the highest violent crime rate in the world, with more killings and kidnappings than in Colombia, Iraq, Afganistan, Israel, and Palestine combined?

The Brazilians become masters in the fine art of Steet Fighting, especially the Brutal Art of Knife Fighting.

Although Brazilians have no access to fine cutlery (the common Knife Fighter uses US\$ 10 knives as weapons), they are second to none on the Brutal Arts of Fighting - and Killing - with Knives.

Now some of Brazil's top experts on this lethal art have decided to bring to the USA their failsafe, foolproof Fighting and Killing System and share their secrets with us. I have no doubt it will prove very useful in these violent, terrorist plagued times, where Big Brother's knee jerk response is to disarm the common folks as they have in Brazil.

No matter if you carry a big Bowie, a thick Tanto, a thin Military Dagger, or a small Tactical Folder, you'll become a dangerous fighter in a weekend if you follow the simple, clear, illustrated instructions in this book - the same instructions that keep millions of Brazilians alive in one of the World's most dangerous places!

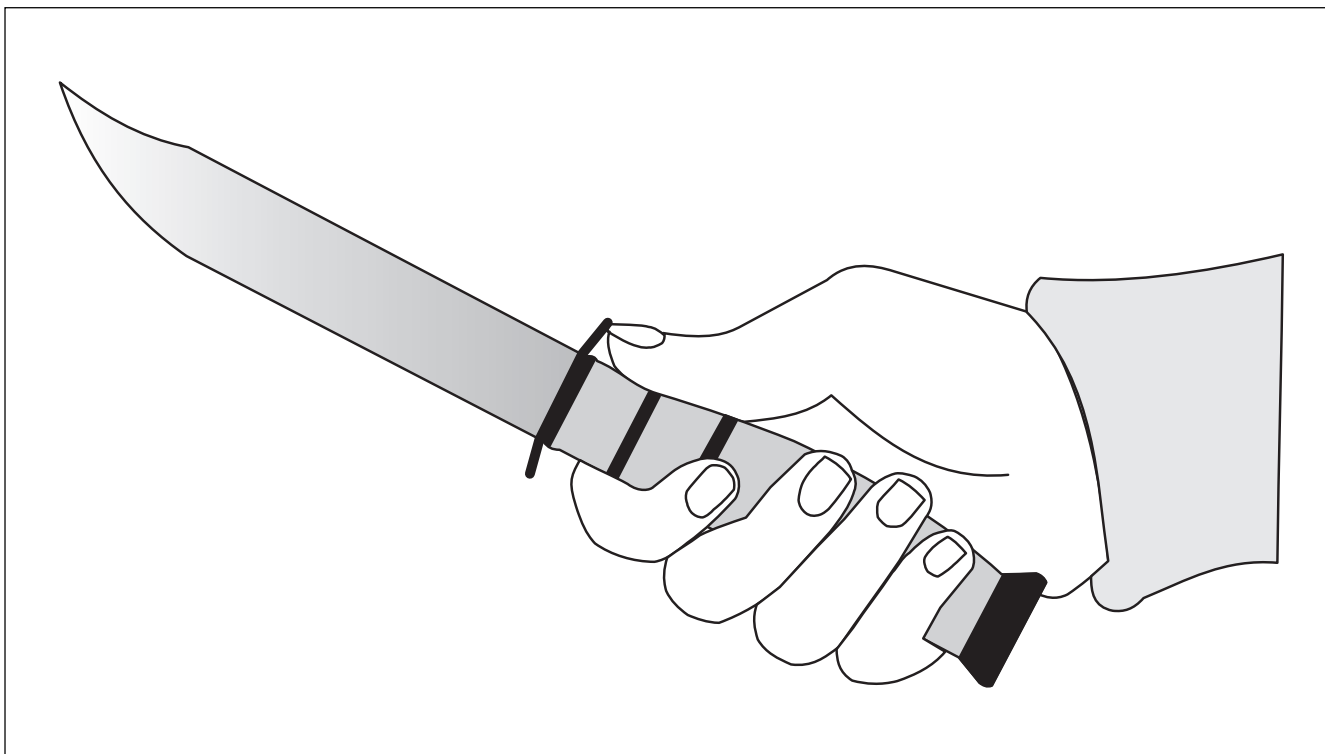

Figure 1





Introduction

In a real life or death battle, your opponent is unpredictable and violent. His only purpose is, in the best case, to hurt you badly, although you must always assume he wants to kill you. He will never make it easy for you, and only then do you realize that all those defensive movements you trained at the dojo are extremely difficult to perform with any degree of success.

We must consider training a technique that can be used by most people, independently of physical limitations, preparing us to adapt our reactions to any particular method our opponent uses, employing only the correct moves and tactics in the confrontation. Therefore any efficient method must be constantly put in practice in order to find solutions to the new violent situations and threats present to our everyday life.

Many martial arts are attached to their traditions too strongly, and thereby stop the development of their methods. When performing formal exercises and moves, they attend their goal of preserving the essence of their style but that does not mean they are enabling their students to best defend themselves from a criminal on the streets. The dynamism and versatility of the chosen method can be the difference between life and death!

The DE-SU (Defense and Survival) method analyzes situations and offers answers. Kni-

ves are very popular with criminals, psychopaths and even terrorists because they are easily concealable, its use is quiet other than screams or howls or other commotion from the object of attack, and they do not present mechanical problems as guns do. Furthermore, knives are easy to use, easy to find and carry, and they're cheap and easily built. Be mindful that they are found in nearly every search police do in the jails.

If the criminals (and their friends) have this advantage, the common citizen should at least balance the situation. Knives should lose their image of being a “criminals-only” weapon and start being seen and understood as a legitimate self defense tool. Besides, in contrast to a gun, they are very useful for everyday tasks such as opening letters, boxes, sharpening pencils, etc. Changing this perception is especially important these days, as gun buyers and owners are suffering pressure by all sides to disarm themselves, being “politically correct” and respecting the human rights of the criminals. The knife has become an excellent option.

It is certainly your best CQC (close quarters combat) self-defense tool. The use of knives for self-defense, the main focus of this book, should be studied for two main reasons: Knowing the risks the weapon presents allows you to better defend yourself against a kni-



fe attack, and to balance forces . With a knife one can confront a stronger opponent or many opponents simultaneously - either against unarmed or armed attacks.

Knives uses

A knife is a tool used by man since the very beginning of humanity and civilization. It's been found among cutting and perforating tools constructed of bones, stones and wood thousands of years old. Its usefulness in a survival situation cannot be overstated. After a plane crash or a ship sinking, a person might take a long time to be rescued, if ever. A knife is the most useful tool to have around making tasks such as shelter building, for instance, a lot easier.

When we compare the biotype in between sexes, it's easy to see that men, in general, have more muscle mass than women, therefore men are physically stronger than women. Superior strength along with surprise and intimidation of the victim is what most sex attackers rely on. To illustrate we can mention that the Park Maniac never used any kind of weapon to dominate, rape and kill his victims.

A basic rule followed by most criminals is to choose those they think will be easy prey, normally being represented by the frail and distracted. Women are seen as an easier target due to their relative frailty. Even if they react with punches and kicks their chances of fighting an attacker off are quite reduced. The racial component of criminal attack should not be ignored either, even if media brainwashing has made white people uncomfortable with confronting the facts of life. Black upon white crime is many times more common than white upon black crime. The reason for that is exactly the same. A criminal will view a white victim, especially a white woman, as being less likely to respond with a threatening level of force. That is, they are viewed

as easy Photokings. In the US, 50% of black males end up doing time in their lives. From this number comes the discrepancy in inter-racial attacks.

Let's now suppose that when attacked, a woman manages to draw a knife, either to threaten him or to immediately cut his flesh. He will then realize that he might have chosen a not so defenseless victim. The look in her eyes changed from fear to anger, her survival instinct takes charge and there is no option. Either she will do whatever is necessary to survive the attack or she will succumb. He then recovers from the initial surprise and decides to go on with his attack, but she is faster and slashes his throat and punctures his eyes. The battle is over. The intended victim is alive and has preserved her moral and physical integrity. Violence exists, it's a fact!! In real situations, most women give up fighting and submit to the attackers for fear of getting killed, but that alone cannot guarantee anything. After raping them the Park Maniac strangled all his victims to death! At the fictitious encounter described above, the most important element is not the knife, but the training, which prepared her to use the knife (or any improvised weapon for that matter) correctly as well as her mental attitude.

The mental aspects of preparation for knife fighting can't be stressed enough. Most people growing up in a civilized society have been trained from birth not to slash and disembowel their playmates. The very thought of using a blade in self defense, therefore, is odious to the common person. It should not be! The situations described and taught in this book are for situations in which the use of a gun would be equally justified. Training with rubber or hard foam replicas of knives in combat situations is the first step to removing the mental block or stigma which would prevent you from defending yourself justifiably in a life or death situation. While we train, we retain our values. We just expand the list of weapons which we can use.



The philosophy of defense with knives

The philosophy here presented is the personal synthesis of knife combat methods, resulting from 30 years studies on diverse martial arts, many real combat experiences, search and research on different systems and information exchange with many experts on the subject. 18 years of experience as a combat instructor in many security institutions and elite military units have provided me with a constant feedback of my methods performance during tactical operations and daily events that constitute the work life of security guards.

Oriental martial arts work on discipline, the constant repetition of movements developing muscle memory, which aims to decrease the time in between thinking and acting. The focus in the fighter's mind is not rationalization but abstraction. Many masters demand total trust from their students as if his methods were absolute and complete.

Occidental fighting methods emphasize questioning, really testing the techniques taught.

It is common to see cross championships where different methods have to prove themselves.

The Ultimate Fighting Championships are the foremost example. Note that all of them follow rules, in contrast to real street fighting situations. The knife, in the hands of a fighter with few months of training, equals the fighting power of a martial artist with many years of hard training.

The most complete methodologies of knife combat come from the Philippines, an archipelago made of more than 7000 islands in the Pacific Ocean. The use of weapons, mainly knives, swords and sticks is taught at the beginning of the training, as opposed to most oriental traditional martial arts, where first one trains unarmed combat techniques only to learn the use of weapons when reaching an advanced level. Native techniques combined with fencing techniques brought by the Spa-

nish conquerers made up one of the richest weapons combat systems in the world beside being an authentic representation of the courage and bravery of a people. These have been synthesized in a unique system which combines physical, religious, cultural and social aspects to it. Most knife combat experts have studied at least a little of the Philippines systems in order to enrich and improve their combat skills. In a knife combat, in order to win or even just to survive it, it's not only necessary to have good instinctive reactions, gained with muscle memory exercises, but also a good combat strategy. Sometimes it is worthwhile sacrificing some pawns in order to get your opponent's queen.

Another great source of knowledge and techniques for knife fighting is the military, which tries to standardize, register and update its training methods for use on the battlefield. The study of tactics and strategies, the good fitness conditioning and the mental preparation for combat provide great help for the soldier to better assimilate the foundations of the knife combat.

A knife is an essential tool for the soldier, helping him during survival or CQB situations. To have the mind opened to new concepts and techniques is a must to any knife combatant. The continuous search and study of efficient training methods is the only way to guarantee the recycling and updating of knowledge and technical and physical skills. Constant training shapes the body and prepares the mind. Finally, proving the techniques in simulated combats, using harmless rubber knives, makes clear the efficiency of the studied methods.

Some methods, undoubtedly, are more efficient than others but with any of them the most important element is the mental preparation. There must be an internal change of the combatant, the development of an unflinching spirit when facing death, the final destiny of every human being, for which so few of us are really prepared to meet.



Concepts developing proper mental attitude

The combatant must harden himself to control and even manipulate his own and his opponent's mind. He must completely dominate his bodily emotions and technical skills. The main obstacles to overcome are fear, hesitation and surprise. The moves to be executed are simple and fluid. The opponent should be just a participant where you can see the void in his defenses. His attacks should be easy to defend and yours fast and lethal.

Keeping the focus - Every combat is violent and bloody, and 'dirty tricks' are used to win them. The focus is on cutting while avoiding wounds to yourself.

Weapons are all the same - They are just tools and a fighter who is skilled in the use of a knife can just adapt these skills to objects at hand. Keys and pens, for instance, can be used on all the angles of attack; one

has just to keep in mind they would be used as thrusting weapons.

Know your targets - A knife allows one to flee, negotiate, hurt or kill the opponent. In contrast to a handgun, one can have, almost literally, surgical precision with it. A skilful fighter must have a thorough knowledge of human anatomy to be able to achieve the expected effect with each attack.

Balance - To keep good balance during a fight is essential for the fighter to be able to defend and attack efficiently; especially considering that a mistake can be fatal. The fighter must feel comfortable and able to move freely. Keeping your feet together or one in line with the other makes you unbalanced (fig. 2 and fig. 3). Just try to resist someone pushing you backwards and sideways. Keeping your knees bent, with your feet apart, following the shoulder line and your weight slightly forward will give a good combination of stability and mobility (fig. 4).

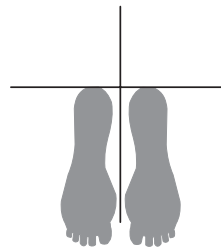

Figure 2



Figure 3



Figure 4





The Triangle - If the combat is linear it will allow your opponent to continue attacking. Triangulation can be divided into two triangles - Male or defensive to be used when evading attacks, and Female or offensive to be used for attacks and counter attacks. They will

allow you to surprise the attacker by being able to break a sequence of attacks and efficiently counter attack. In order to be in an advantageous position when in combat we should always break with our opponent's line of attack.

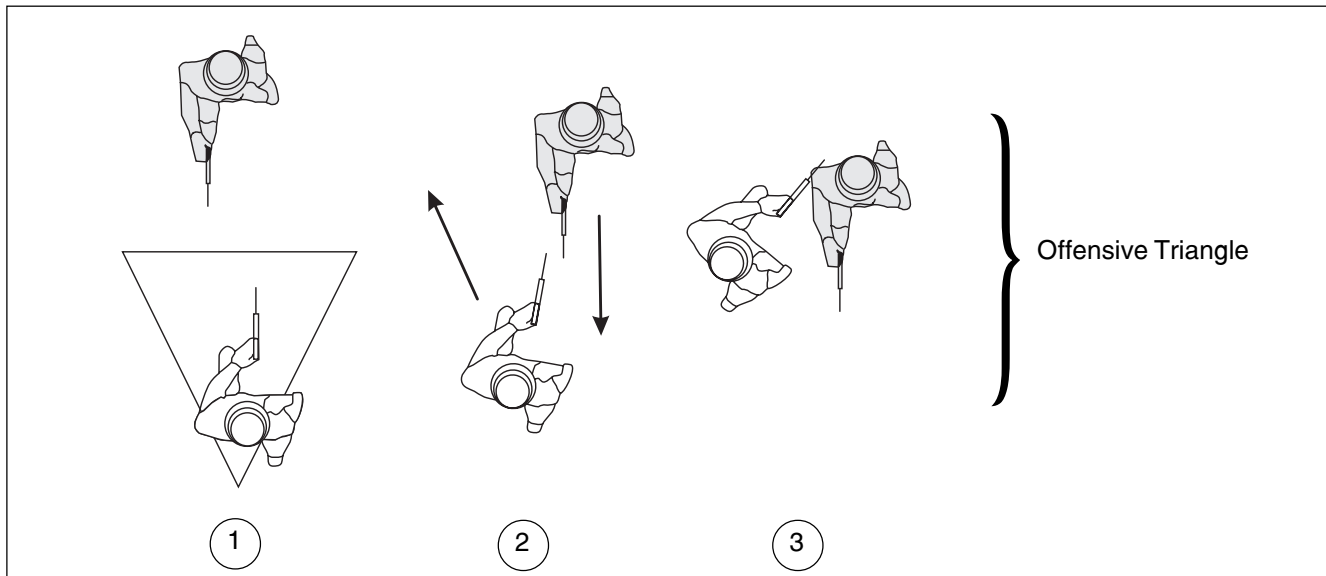

Fig. 5 - The attacker steps forward, the defender steps forward diagonally and counter attacks.

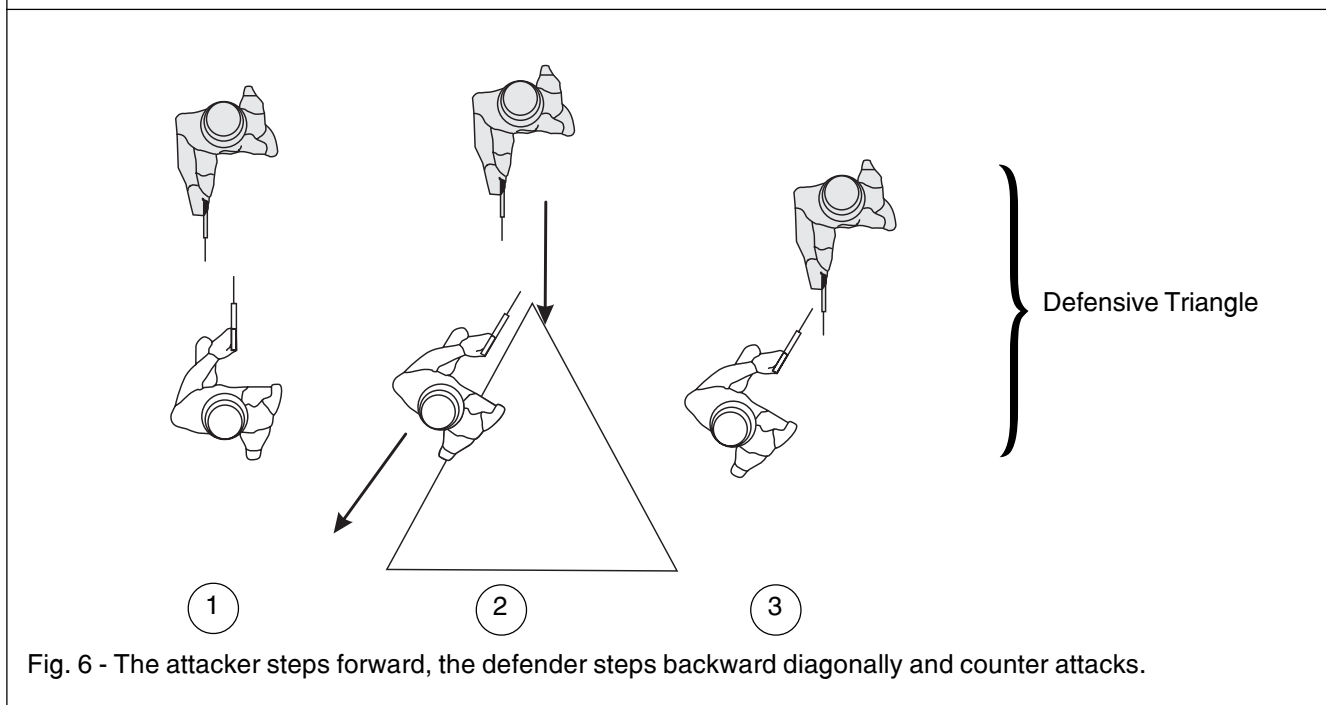

Fig. 6 - The attacker steps forward, the defender steps backward diagonally and counter attacks.

Dead/ Live Side - When triangulating it's preferential to move onto the 'dead' side of your opponent (outside his guard), making it harder for him to counter attack. The Live side

is represented by his frontal body side where his 'live hand' allows continuous and effective actions for attack and defense.



The 'Live Hand' - The live hand is the empty hand. Used in combat to block, pass, push, pin and hit.

Inertia - Is the tendency of a body to continue the direction of movement unless something, like a block for instance, stops it. The

bigger the body mass or its speed, the bigger the inertia. The fighter can use this for his advantage by:

1. unbalancing his opponent
2. deflecting his opponent's attack
3. Adding forces to his opponent's momentum.

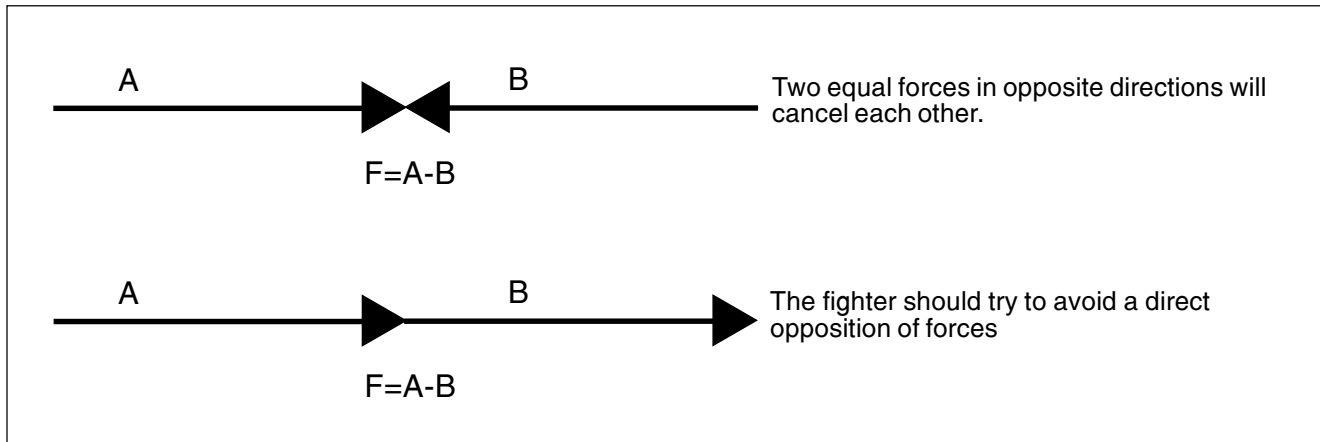

Distances - Being at the correct distance when in combat will avoid wasting attacks in the air, which would expose yourself to counter attacks, and it allows a better use of strategy. There are basically three combat distances:

Risk Area - a distance that does not allow attacks but also that can be shortened quickly.

It varies accordingly with the number of attackers.

Primary Combat Area - where is possible to attack, defend, kick and punch but no grappling.

Hand-to-Hand Area - in this distance grappling, throws, locks and ground fighting is possible. It should be aggressively avoided!!

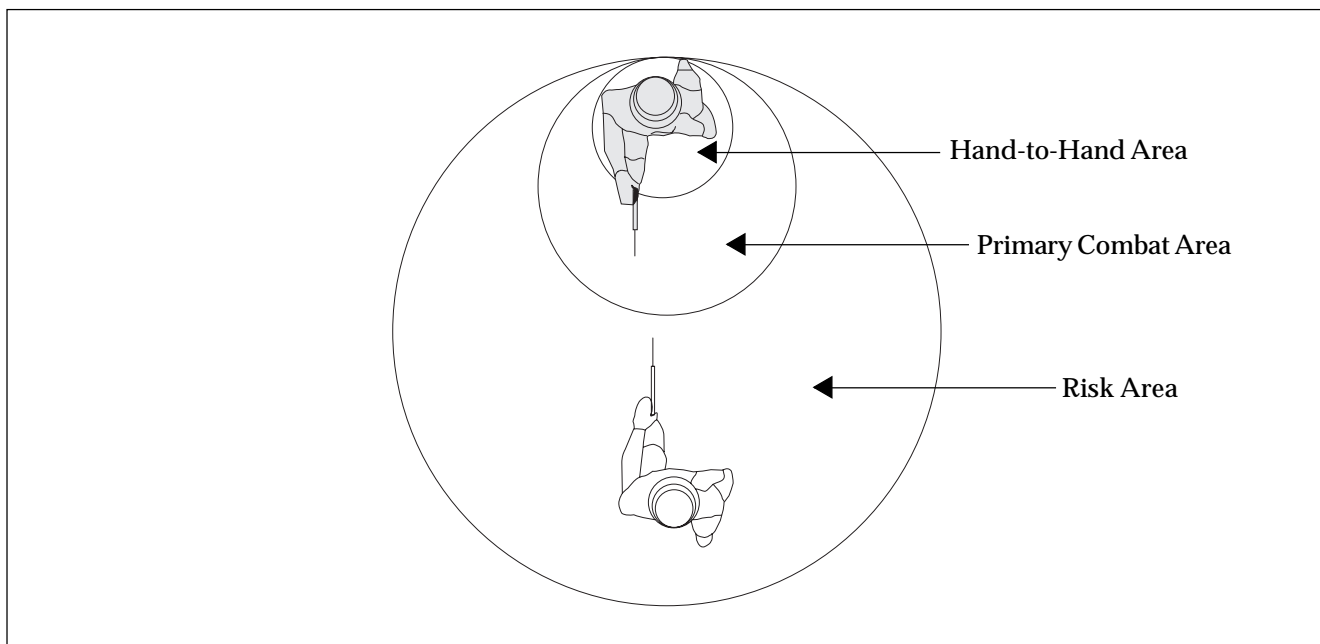

Fig 7 - In combat there are only 3 areas to be considered. It's important to keep your opponent always in front of you with compensating turns in case of him triangulating.





✎ Bloody Brazilian Knife Fighting' Techniques ✎

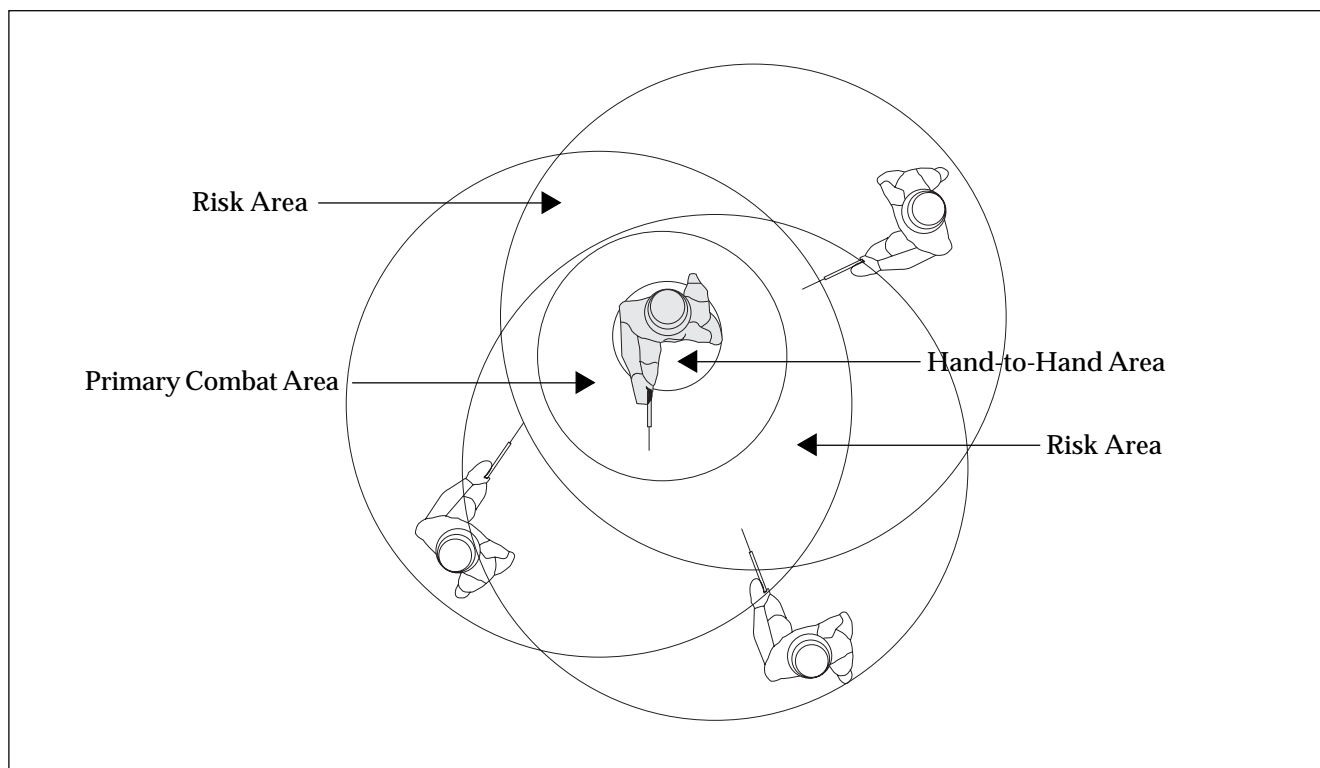

Fig 8 - When facing multiple opponents, the Risk Area is increased considerably as you become exposed to many combat fronts.

Positioning - A good understanding of distances allows for a better positioning.

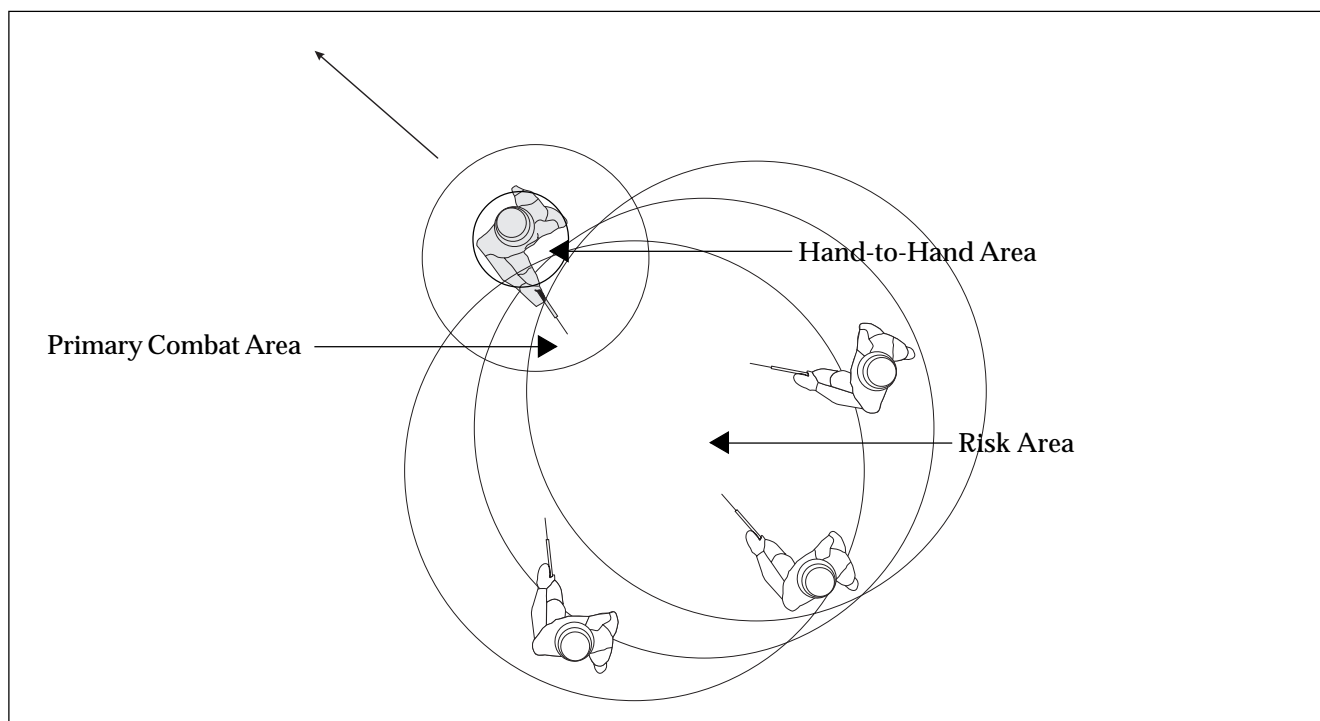

Fig 9 - An intelligent positioning decreases the Risk Area and the possibility of being cut.

Explosion - This is the primary concept of attacking with surprising speed without giving away our intention. Many combatants for knife combat. Explosion is the capability



display a stance which makes them vulnerable to a fighter with good explosion.

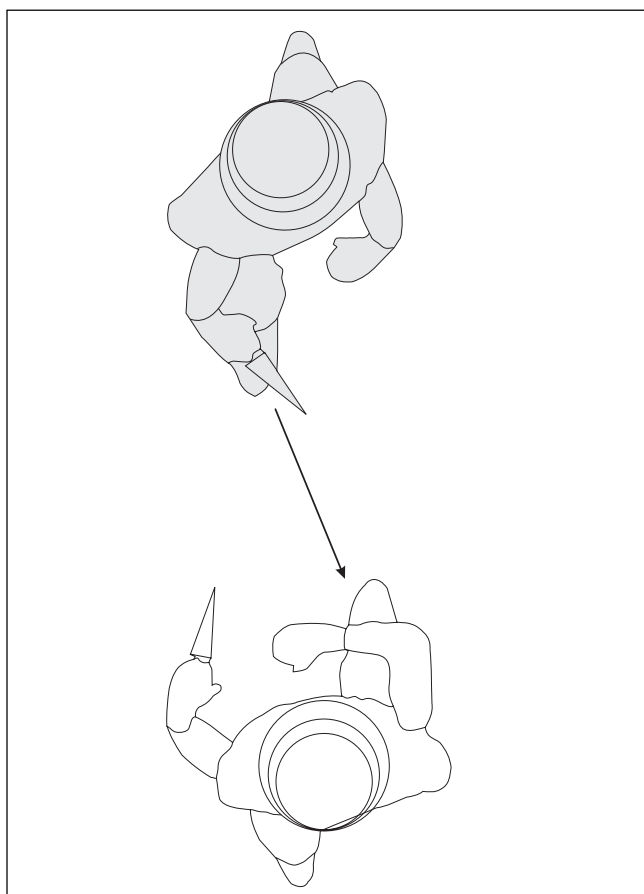

Fig 10 - A fighter who keeps his hand out front, inline with his opponent's knife, can have it easily cut by a fighter with good explosion. Taking the 'first blood' out of your opponent is excellent as psychological pressure making him more vulnerable to subsequent attacks.

Timing - Attacking and defending at the correct moment is essential for success. An experienced fighter anticipates his opponent's attack, making the most of the moment to counter attack.

Know the Weapon, study your opponent - To know knives and their different types and variations is essential to being aware of the risk offered by it (a dagger will be used to thrust, a kukri to slash, etc). By studying different techniques we will be better prepared, 'knowing' what to expect from an attacker. Make a quick analysis of your attacker, his reasons, his positioning, his weapon, his state of mind, etc.

Never underestimate your opponent - One of the most common errors is to underes-

timate your opponent. An experienced fighter can, after many combats, feel superior to anyone and feel that he can win any fight. This can be fatal! The prepared mind avoids surprises.

Always have a back-up weapon - It's important always to have a back up knife. It's possible to lose the main knife in combat and having a back up will be essential to keep a balanced combat.

Attacking Areas - The human body can be divided in five main areas of attack:

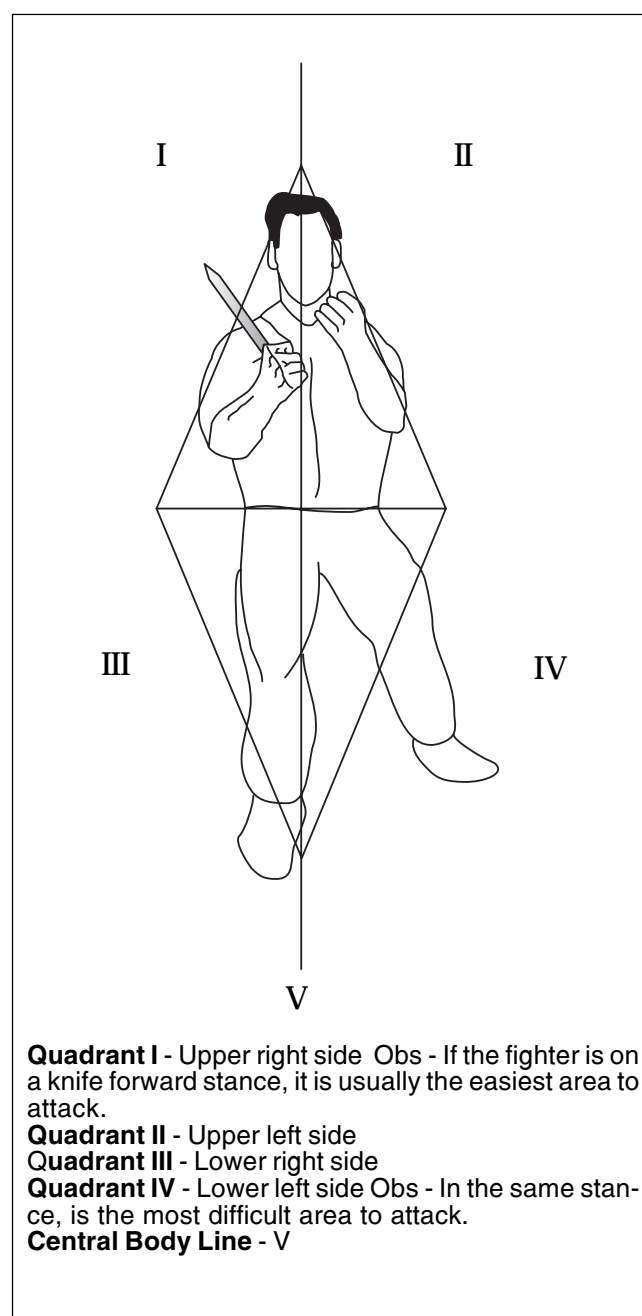

Quadrant I - Upper right side Obs - If the fighter is on a knife forward stance, it is usually the easiest area to attack.
Quadrant II - Upper left side
Quadrant III - Lower right side
Quadrant IV - Lower left side Obs - In the same stance, is the most difficult area to attack.
Central Body Line - V

Fig. 11



The knife makes equal the weak and the strong - With a knife, a person who is physically weak can engage in a combat with a stronger person on equal terms. The knife should not be seen as a 'criminal's weapon' but as a self-defense tool.

The knife completes other traditional Martial Arts - Generally any weapon is a bonus to a martial artist when in combat (swords, sticks, knives, etc). Knives are the best weapons to be considered by the modern fighter.

Symmetry - Any knife fighter should be as skilled with the stronger hand as with the weaker. During combat, due to injuries sustained, switching hands can be absolutely necessary.

Precision - The correct measure of distance of attacks is essential not only to strike the opponent but also to avoid throwing attacks in the air. After all, in doing that the fighter is increasing the opponent's chances of counter attacking.

Psychological preparation for self defense with knives

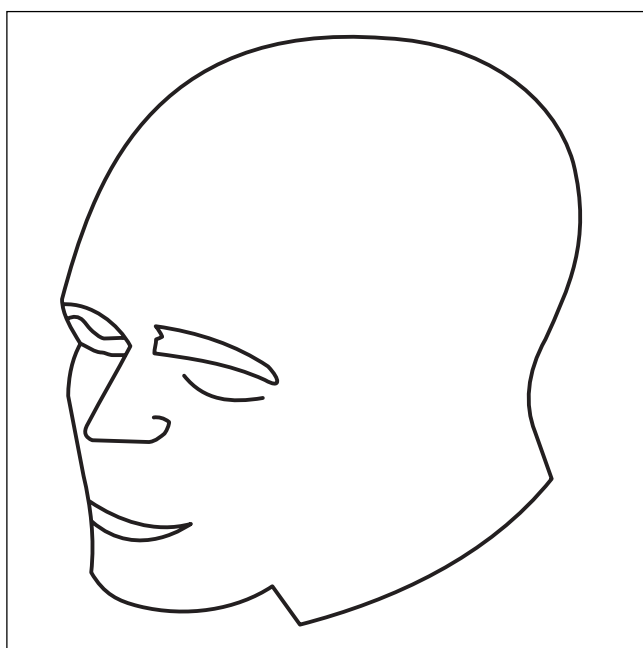

Fig. 12

Preparing for real combat

Imagine yourself facing a person armed with a knife, intending not only to intimidate but actually to kill you. Imagine his shining blade, cutting the air, going fast towards you. Most of us have a natural fear of being cut. In our daily lives it is relatively rare to get cut, it being usually the result of an accident. When it happens it attracts all of our attention as we give immediate care to the wound, no matter how small it is. Many people get sick or even faint when seeing blood. In a combat with knives, the wounds are usually big, painful and serious, demanding great medical care. Even the small wounds can be incapacitating. In fact, even a small cut on our hand can be enough to decrease our concentration, our confidence and our 'fighting spirit', besides the damage in itself. In a combat scenario, it is necessary to be able to control these feelings even if seriously hurt and also in case of your opponent being hurt. The control of pain is very important as well as a certain coolness to deal with this nature of injury. Besides, this isn't the movies, and your opponent is not going to give up fighting after being hurt. He will keep on fighting until his forces are completely drained.

It is necessary to be mentally prepared for the realities of a knife combat. The scene (the sounds, the smell and the visual) will be very different from what we are used to experiencing during training. We must be prepared to get hurt and keep on fighting. Giving up or panicking are not choices, as they will inevitably lead to death.

When training and we get 'cut' it is very important we understand the gravity of what has happened. It is common to give a little pause to analyse what was done but this habit can also work against us, as it makes us used to pausing after getting hurt or hurting the opponent. In a real fight one cannot just pause after being hurt, as that will mean defeat and death. The respect and care for the opponent during training also creates bad conditioning



as it shapes our attitude. In a real fight one should try to distract the opponent in whatever way to increase the chances of creating the opportunity for a successful attack. One must remember that in order to survive there is no set rules when fighting. To emotionally dominate the opponent one can resort to words and gestures to supplement the fighting techniques. Intimidation and deception might lead you to winning the fight. When training try to be as real as possible, taking care to avoid serious injury.

The Feared Opponent - This is something we see in the movies but in real life it can be very frightening is to see your opponent self-mutilating to prove he feels no pain. Never underestimate someone who is unprepared, 'against the wall', under the influence of alcohol and drugs, desperate and has nothing to lose. They usually are capable of unthinkable feats and are able to surprise us and even seriously hurt us. If possible, before attacking observe and study your opponent. Note his attitude, stance, confidence and ability. Remember what Sun Tzu said: "If you know the enemy and know yourself, you need not fear the result of a hundred battles. If you know yourself but not the enemy, for every victory gained you will also suffer a defeat. If you know neither the enemy nor yourself, you will succumb in every battle."

Controlling your feelings - In the same way you can induce emotional responses on your opponent he can do the same to you. Therefore emotional control is essential for one who is dealing with the lives of at least two persons. You must be aware when it is necessary to fight and when is wise to retreat and escape. Besides, do not let yourself blinded by pride or revenge as you might regret it later. One fights using his knife for self defense only.

Acting with Discretion - The most successful attacks are those which get the opponent by surprise. To show you are well prepared for fighting might simply reveal your weapons and weaknesses. Besides, to the people

witnessing the combat, your opponent might be seen as a victim and not as an aggressor, no matter what he's done. In this context they might even attack you.

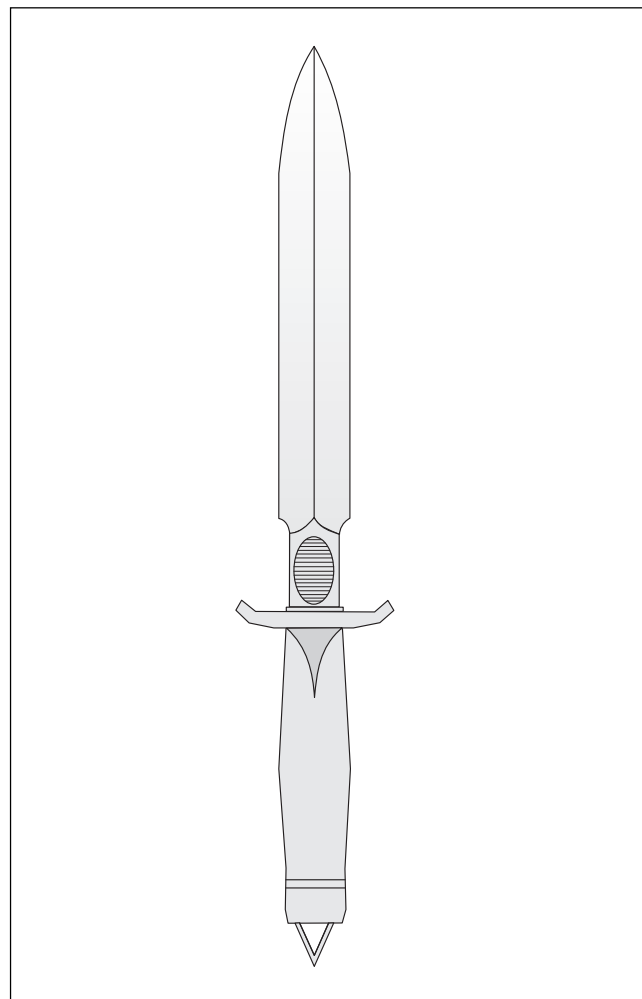

Fig. 13

Types of combat

Knife against Knife

It's a rare situation these days. Sword duels have a rich history, but knife duels just have never really been part of Occidental culture. This type of combat ends in a few seconds if the combatants differ too much in skills, or it can even end with the death of both combatants if their skills are of similar level. To get in a combat of this sort the fighter must be prepared to die. It's also possible to have a com-



bat against more than one attacker armed with knives. In this case, if they are experienced, they will try to attack you on different fronts to increase their chance of winning. With the correct positioning is possible to decrease the risk, turning the combat to linear attacks as shown under the Concepts chapter.

Knife against Hand

In the real world, this is the most common scenario. Knives are commonly used by assailants for intimidation and often found in all kinds of fights. Treacherous attacks due to stupid reasons are not rare. The problem is not the weapon but its user. In this situation the one with the knife has the obvious advantage. It can be justified if the user is physically inferior to the aggressor and for self-defense.

Knife against unarmed attackers

Usually using the knife against someone unarmed is seen as a cowardly thing, but it can be used to balance a combat if one faces more than one opponent. There is a saying, which says: "It is better to have 5 lions than 500 sheep". To show your teeth frightens the sheep.

Knife against Firearm

The advantage is related to the distance in between the combatants. At a short distance (arms length) the knife has the advantage; at longer distances the firearm has got it. The firearm user should be at least 18 feet distant to consider himself safe.

Knife against Stick

When used with skill, the stick will have advantage against the knife due to the distan-

ce in between the fighters. That advantage, however, is totally related to the fighter's skills.

Unarmed against Knife

It will depend on the skills of both fighters but the obvious advantage is with the one armed with the knife. Other than unarmed against gun, this is the worse scenario one could find himself in and usually running away will be the best strategy for surviving.



Photo 1



Photo 2

Photo 1 and 2 - Students training defense with knives

Knife targets

Cutting Wounds - This type of wound causes pain (distraction), bleeding (dimin-



nishing your opponents fighting will), movement restriction and in many occasions death. There are two types of cut: 1 - by pressure. For example scissors, guillotine, etc 2 - by pressure and sliding. For example swords, knives, razors, etc. On arms and legs, transversal slashes that cut muscle or tendons might stop movement providing an opening for attacks or even ending the combat. On joint areas (neck, armpit, pelvis) the blood vessels are located near the surface. There are major arteries in all the places where one can feel the 'pulse', but be aware that in some cases very close to these areas the artery is under muscle, tendons or even bones. In such cases only one cut will not be enough to reach it.

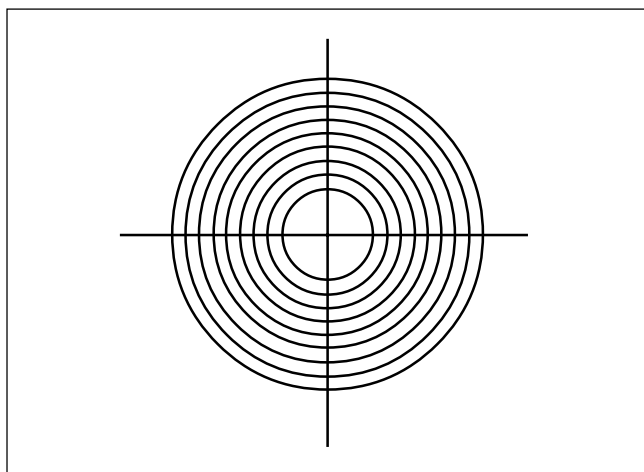

Perforation wounds - In Combat, it's not as easy to cause perforation wounds as one may think it is. The rib cage or even a leather jacket can prove to be an obstacle impossible to penetrate. Try to thrust against a piece of foam and you will see that is not as easy as it seems. Besides, one has to be very accurate with the attack to be able to cause the expected effect immediately. The regions of the neck and thorax are preferred as usually they are fatal. Apart from the vital organs, perforations take a while to bring results as the victim bleeds away. Many times the bleeding will stop by itself due to the contraction of muscles and blood vessels.

Contusion wounds - Can be lethal when on sensitive areas such as the head or neck.

They can be inflicted with the handle or back of the blade.

Skinning wounds - cause extreme pain but are not immediately lethal. They are good as distraction wounds.

First aid: Amputation - place the amputated part inside a plastic bag and immerse it in cold water. Stop the hemorrhage and protect the open wound. Seek medical help immediately.

Perforation wounds - usually present a small entrance wound, therefore it may have little external bleeding. However a knife can damage structures deep inside causing extensive internal bleeding. Always look for both entrance and exit wound. Do not try to remove the knife if it is still located in the wound. Apply a dry sterile dressing and seek medical help.

Perforation on thorax - breathing difficulties can be a sign of a punctured lung. Diffused abdominal pain can be evidence of blood or excrement in the abdominal cavity. Seek medical help immediately.

Superficial cut - wash the wound with fresh water and seek specialized help for the possible need of stitches and further medications. If the bleeding continues apply direct pressure for a few minutes elevating the member until it stops.

Injuries on tendons, muscles or nerves - stop any bleeding by direct pressure and immobilize the limb. Protect the open wound with clean sterile dressing. It will be necessary to seek surgical intervention in a proper medical environment.

Avulsion wounds - if possible replace the avulsed flap to its original position. If the wound is dirty do not replace it. Seek medical help.

Open fractures - commonly called compound fractures - completely cover open wounds with a clean sterile dressing and immobilize the limb on the same position it is in. Seek medical help.

Head injury with loss of consciousness - the patient needs medical evaluation even if he recovers consciousness. A concus-



sion is generally the consequence of being knocked out.

Neck or spine pain after traumatic injury - the patient must not move to avoid possible injury to the spinal cord. Only a trained team of rescuers should be allowed to move him/her to receive further medical care.

Hemorrhage - the bleeding of an artery can lead to hypovolemic shock (low-volume of blood) in a few minutes. It is therefore important to control the bleeding as soon as possible. Apply direct pressure to the wound. Elevate the member. If still bleeding try applying pressure to a pulse point above the wound. When losing too much blood the patient will feel thirsty, but giving water will not improve his/her condition. Seek medical help immediately.

Knife Attack Techniques - There are two main types of attack with a knife: Slashes and Thrusts.

Slashes - the edge of the blade slices the target. The larger the surface and the longer the time in contact, the larger the cut. The sharper the blade the deeper the cut.

Thrusts - the tip of the blade goes through perforating the target. It can be done in a fast multiple sequence of attacks. A deep thrust can be made even more devastating by twisting the knife when inside, or it can be followed by a slash to maximize damage.

Amputation Attacks - heavy weapons can be used to amputate parts of the adversary body.

Attacks with the handle - it is possible to use the knife handle to hit the opponent.

Thrusting to control - by thrusting the knife deep in the opponent's body we can use it as a handle to control and move him around.

Throwing knives - it is possible to throw the knife when your opponent is outside the attacking distance.

Contusive and cutting attacks - Usually the result of an attack with a heavy and badly sharpened cutting weapon like a machete or an axe.

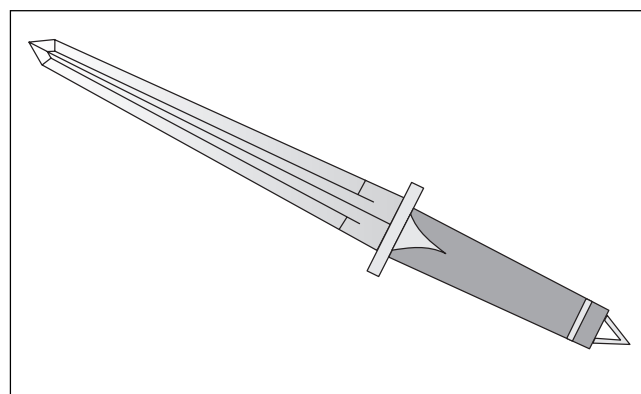

Fig. 14

Knife characteristics

Double edge - With the option of using both edges to cut, we increase the range of attacks. The double edge also makes it easier to release your knife hand in case your opponent grabs it.

Decreased resistance of blade.

Not good when using as a tool for carving and other jobs.

Single and a half edge - Cuts better than a double edge knife because the blade is stronger.

Single edge - The most resistant blade with a bit less penetration than the others and the obvious disadvantage of cutting only on one side.

7 in. long blade - Considered to be an ideal compromise between weight, agility and reach, is the common size found on military knives.

Blade thickness - A thicker blade will be more resistant but it will be heavier.

Blade width - The wider the blade is, the more severe the damage on thrusts and the heavier it will be.

Blade hardness - The blade should be in between 55 and 59 Rockwell to avoid too much bending or breakage.

Handle - It should provide a good secure and comfortable grip even when wet with sweat or blood. Those shaped like knuckle-dusters make it very hard to change grips efficiently. Cylindrical handles make it difficult to know exactly where the edge is.



Folding Knives - They must have one hand opening. In the urban environment they can be easily concealed. Usually they do not exceed 4 in. blade.

Blade Types

Many blade types can be used for self-defense, depending upon their design, use, material and carry. One must choose it according to its main intended use, but as with any tool it must not be super valorised as the main factor to win a combat. There are many different blade types around the world, and they are generally a reflection of the culture in which they developed. The knife has been one of the oldest tools in history being used since the Stone Age.

Knife:

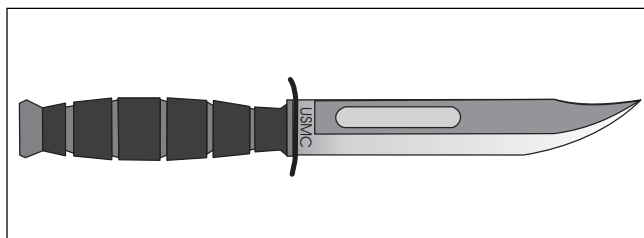

Characteristics - It has only one edge although it might also have a half edge on its back. Usually their sides are symmetrical.
Attack Types:
Primary - slashes
Secondary - thrusts, contusive and skinning.

Dagger:

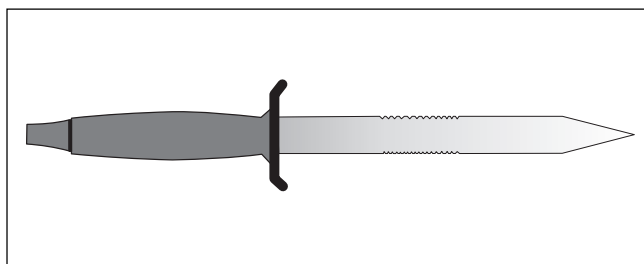

Characteristics - It has two edges with symmetrical sides.
Attack Types - Primary - Thrusts (penetration)
Secondary - Slashes, contusive skinning.

Balisong:

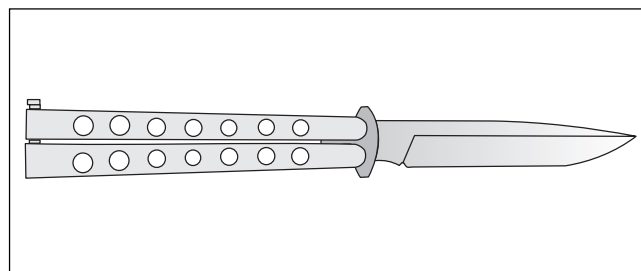

Characteristics - Compact Philippine folding weapon with a single or double edge and with many different designs.
Attack Types -
Primary - Slashes
Secondary - thrusts, contusive and skinning.

Push Dagger:

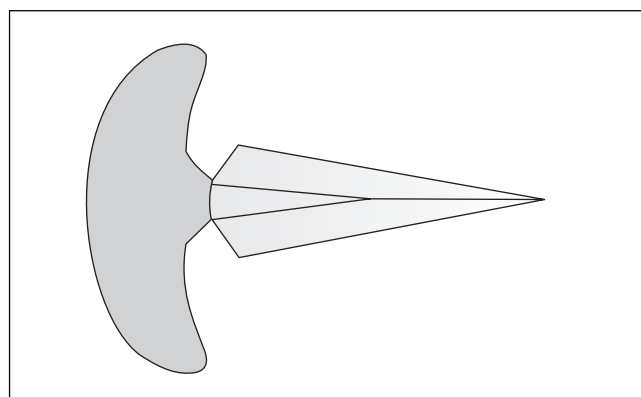

Characteristics - It is small blade with transversal grip.
Attack Types -
Primary - Thrusts
Secondary - Slashes

Stiletto:

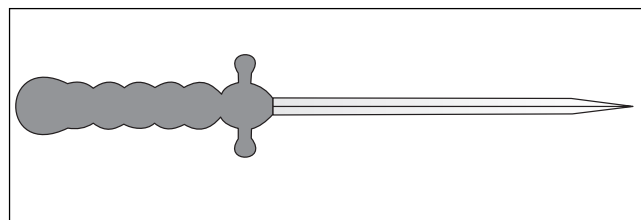

Characteristics - It has a long triangular dull edged blade with a sharp tip providing good penetration.
Attack Types -
Primary - Thrusts
Secondary - contusive



Tanto:

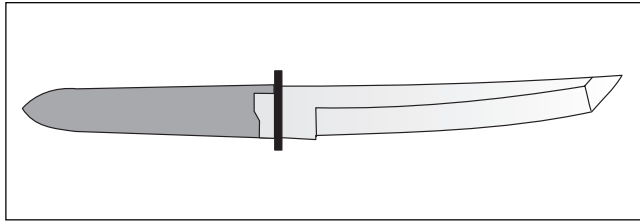

Characteristics - Japanese weapon with a curved single edged blade. It provides excellent penetration.

Attack Types -

Primary - Thrusts and slashes

Secondary - contusive, skinning, and amputation

Razors:

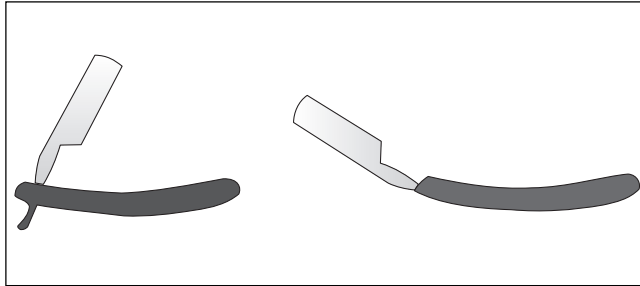

Characteristics - Small size folding single edged blade with a square tip.

Attack Types -

Primary - Slashes, skinning

Secondary - Contusive

Utilitarian (aka: the Swiss army knife):

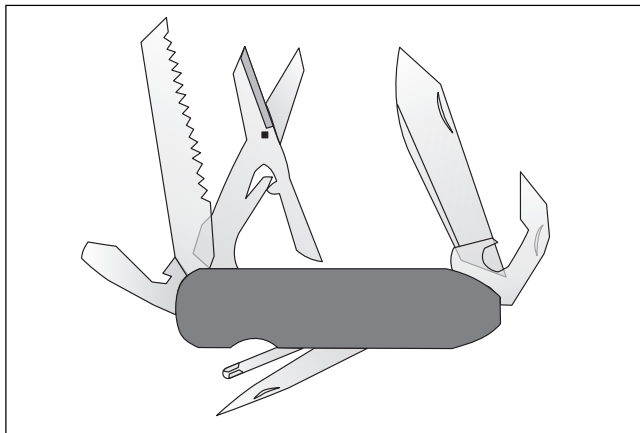

Characteristics - Multi use tool with different tools folded inside.

Attack Types -

Primary - Slashes and skinning

Secondary - Thrusts, contusive.

Folding Tactical Knives (aka the switchblade knife):

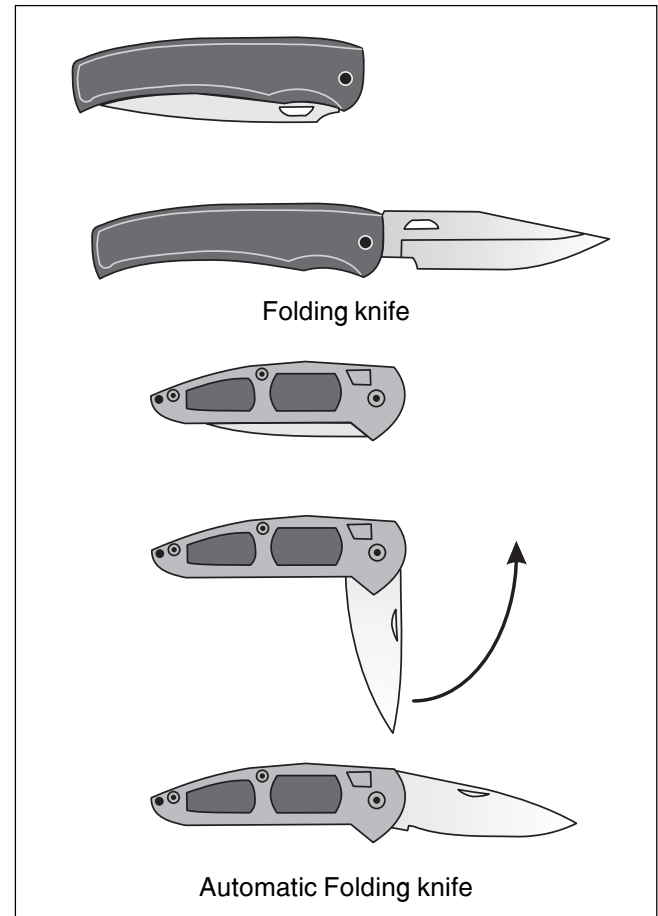

Characteristics - They come in many sizes and designs, allowing user to open them with only one hand or at the touch of a button.

Attack Types -

Primary - Slashes and thrusts.

Secondary - Contusive and skinning.

Kris:

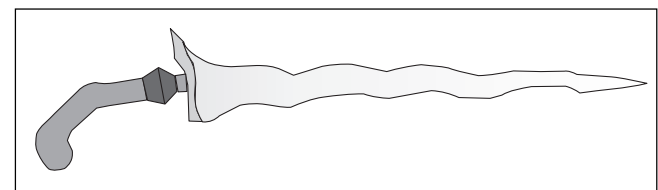

Characteristics - Malaysian weapon with an asymmetrical curves design (undulations), made of iron with many emblems and decorations on the blade. It used to be a status symbol. During its time the warriors used to wet its tip in poison.

Attack Types -

Primary - Thrusts

Secondary - contusive, skinning



Kukri (aka the Ghurkha knife):

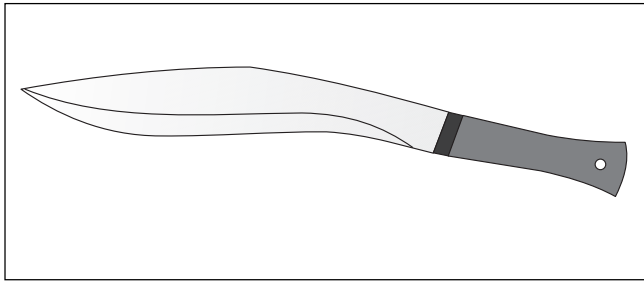

Characteristics - Heavy Nepalese weapon with the size of a small sword. It's the signature weapon of the Ghurkhas, the feared Nepalese soldiers who fight for the British Royal Army.

Attack Types -

Primary - Slashes (which due to its weight end up amputating or beheading the enemy).

Secondary - Contusive

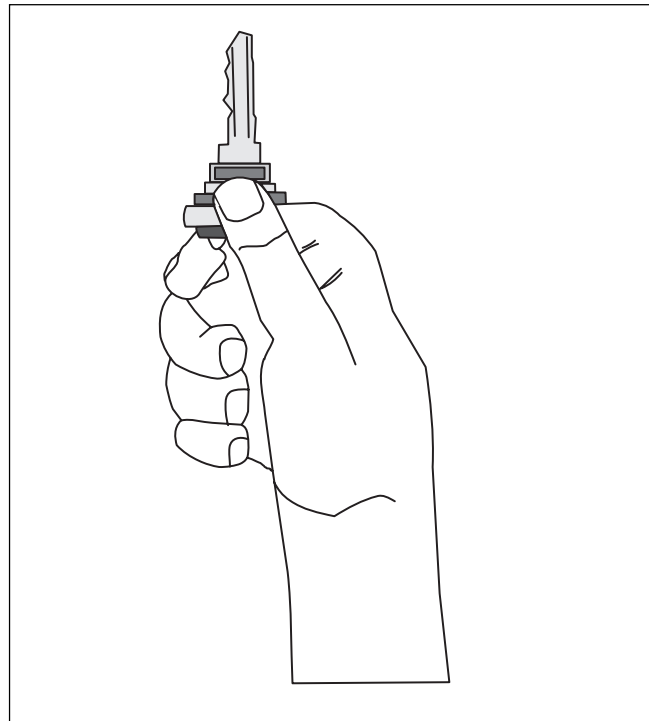

Fig. 27 - Keys

Improvised weapons

Every day mundane objects can be used as knives, and the same techniques can be easily adapted. This concept is interesting to various self-defense scenarios. No matter where you are observe everything around you which could be used as a weapon.

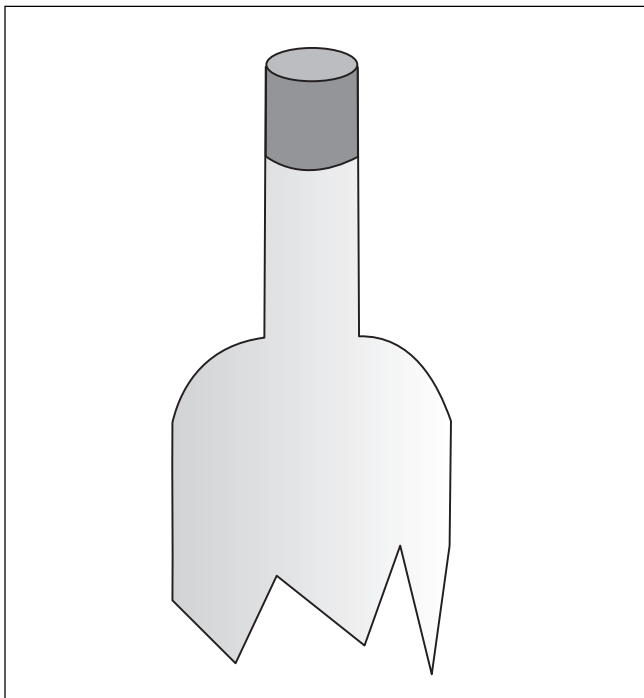

Fig. 26 - Broken bottles

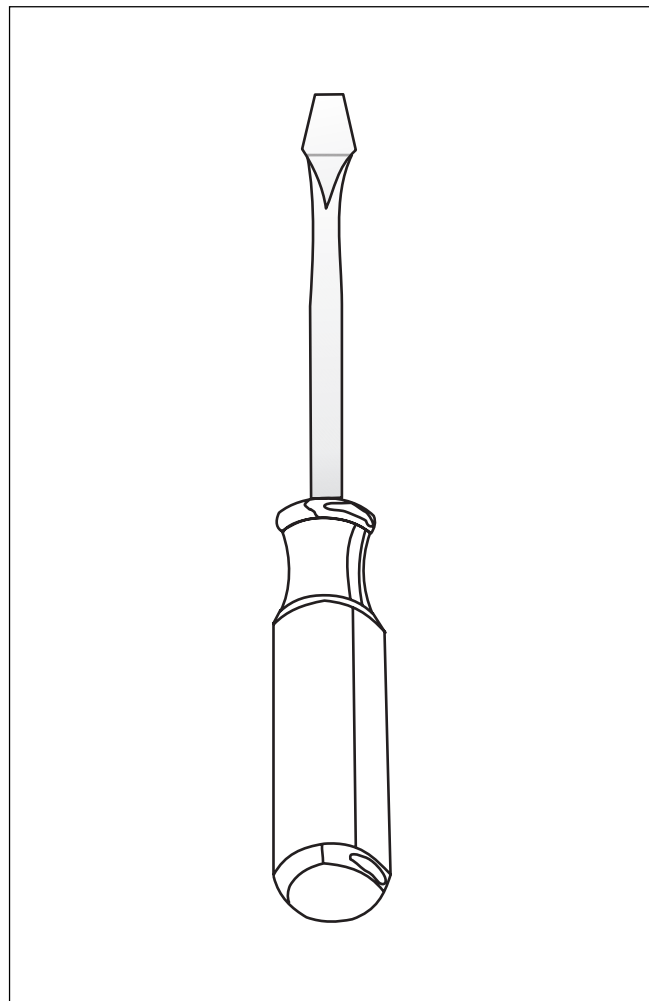

Fig. 27 - Keys Driver



Bloody Brazilian Knife Fighting' Techniques

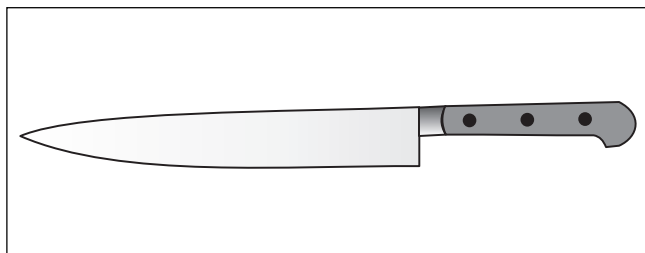

Fig. 29 - Kitchen Knife

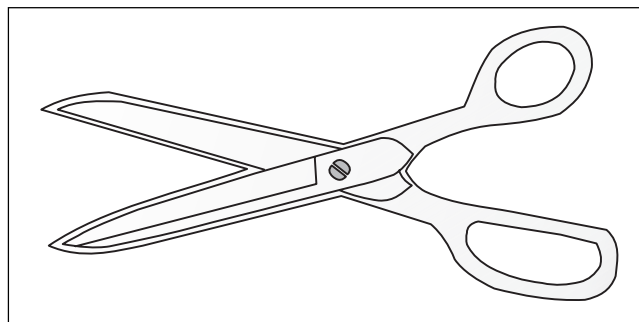

Fig. 31 - Scissors

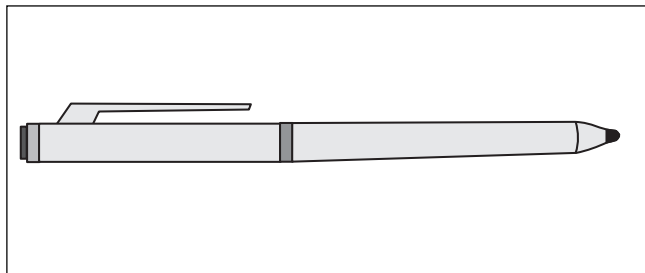

Fig. 30 - Pens and pencils

Attack types

Knives and many other objects can cut or perforate skin and contuse. Criminals use the most diverse way to cause violence. Attacks can be categorized as:

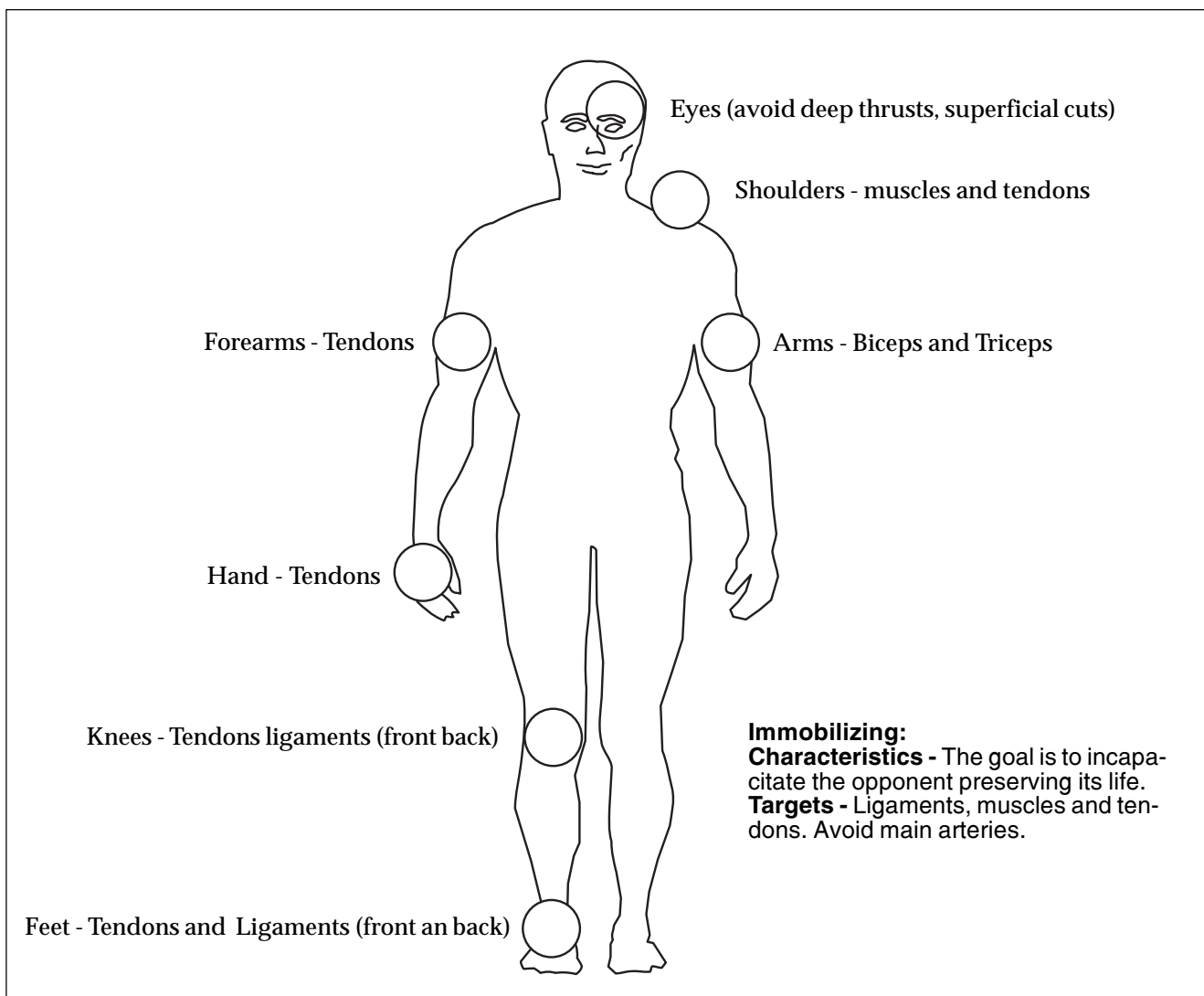

Fig. 32



Vessels:

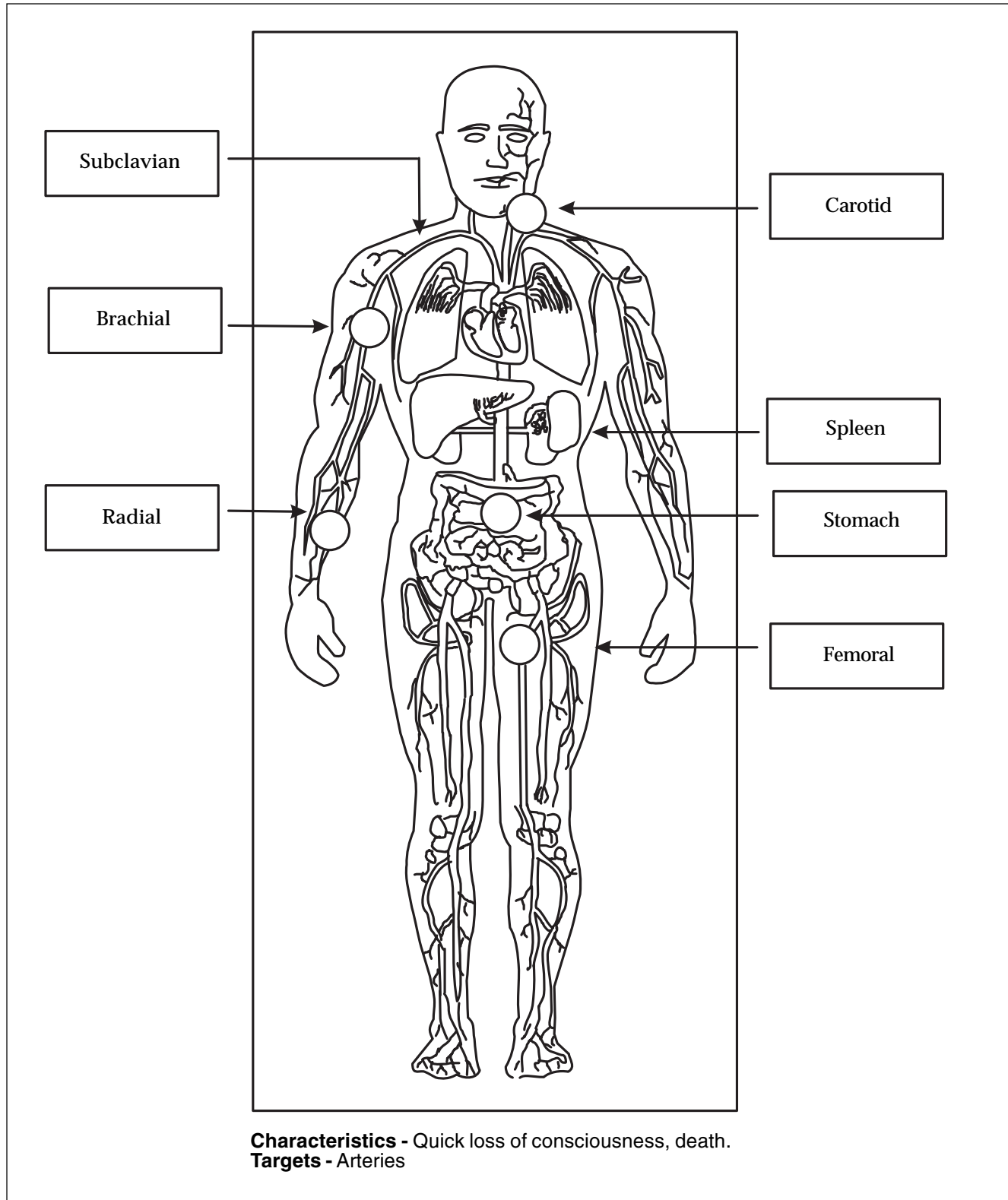

Fig. 33



Kill

Shots:

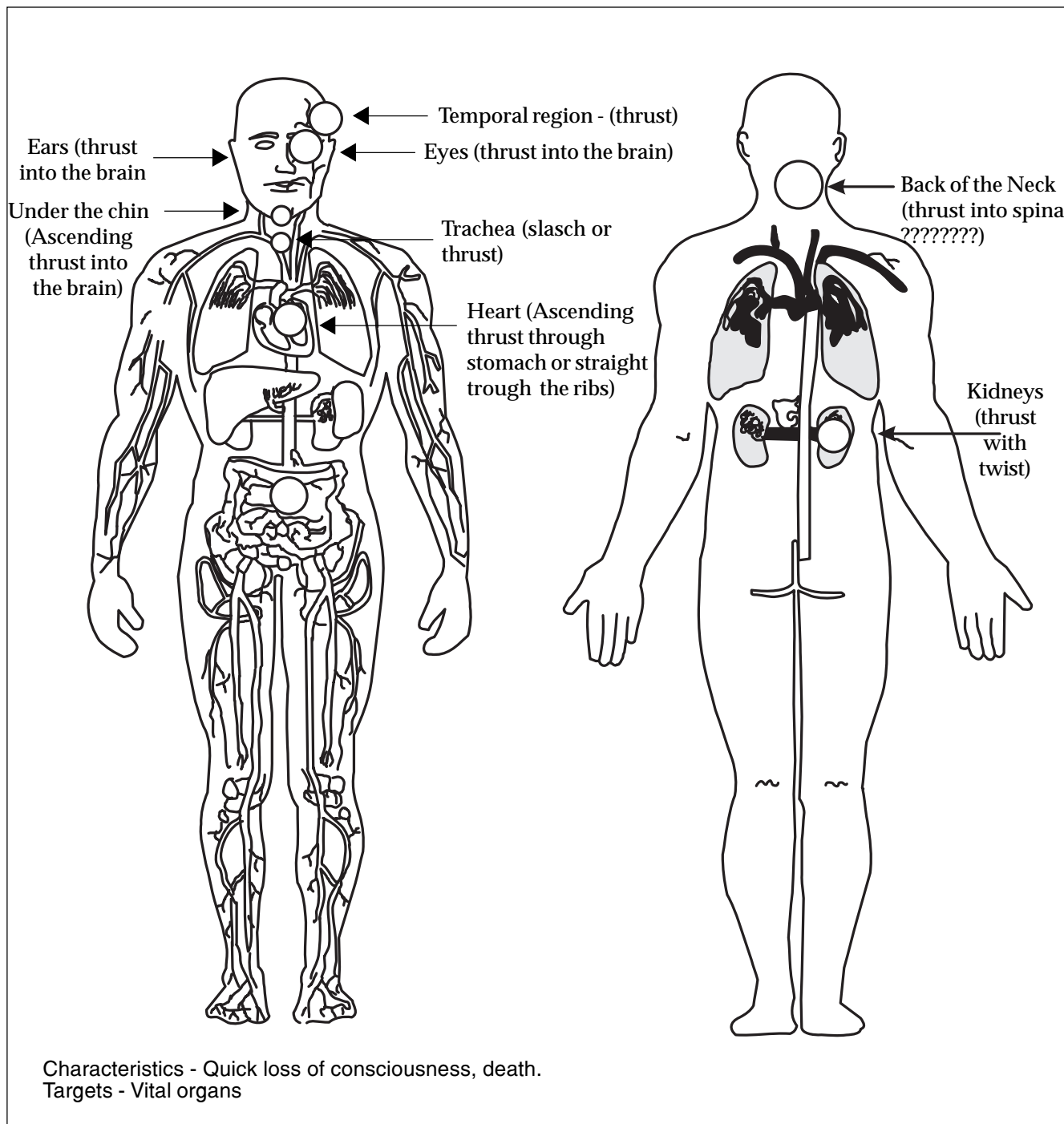

Fig. 33

Grips

The most basic skill a fighter must master to use a knife as a combat weapon is the grip. The way a person holds the knife reveals one's

skills and can even cause the opponent to give away the strategies which he is planning to employ. A good grip shows efficiency and opens up the main attack angles that will be used. It also allows for power in those attacks.





Saber:



Photo 3



Photo 5

Characteristics: The blade is positioned to the front of the hand with its main edge turned downward, the thumb pressing the knife's guard, the fingers wrapped firmly around the handle, and the wrist remains loose (Photo 3). This grip allows for a better accuracy of attacks, flexibility to change grips (Photos 4,5 and 6), longer reach and types of attacks but it also exposes the thumb to injuries by hitting hard structure on the opponent's body (bones, clothing, belts, etc).

The ideal distance: secure area, and primary combat area.



Photo 6



Photo 4

Reverse:

Characteristics: The knife is held with its blade turned downwards or towards the elbow (for deception) with its main edge turned to the opposite side of the thumb. The thumb can be positioned on the pommel (Photo 7) or around the handle. The reverse grip makes it easier to attack with a slash as a primary attack, being followed by a thrust as a secondary attack. It restricts the distance of attack but it



makes it a lot harder for an unarmed person to be able to catch and control it. The thumb over the pommel (Photo 8) allows for more powerful attack stopping the knife from sliding down on the hand if it strikes a bone or other hard surface besides increasing a little bit the distance of attacks. This grip also allows using the knife to be used, after penetrating the shoulder for example, to immobilize, to pull or to control the opponent.

The ideal distance: primary combat area and hand to hand area

Hammer:



Photo 7



Photo 8

Characteristics: The fingers are wrapped around the handle with its blade pointing forward with its edge pointing downwards

(Photo 9). This is the most basic grip of all being used by beginners and experts alike. It allows easy change of direction of attacks but it's not as accurate as the saber although it has its same reach.

The ideal distance: Secure area and primary combat area.

Florete or Fencing:



Photo 9

Characteristics: The fingers wrap around the handle with the blade pointing forward and the edge turned downward (Photo 10), the thumb is positioned on the side of the handle. This grip is very versatile allowing slashes thrusts or contusive attacks, besides an excellent reach. All levels of fighters use it. It allows the change of directions by using the wrist.

The ideal distance: Secure area and primary combat area.

Foil:



Photo 10





Characteristics: The hand holds the knife as if this were a sheet of paper; the thumb can be before or after the guard (Photo 11). The foil grip allows for a good reach but it is difficult to use with knives with a cylindrical handle, the thumb can maintain a good control of the knife or let it loose with ease depending upon on the handle design.

The ideal distance: Secure area and primary combat area.



Photo 11

Peek a Boo:



Photo 12

Characteristics: The fingers are wrapped around most of the weapon limiting its use (Photo 12). It's a grip which limits attacks in reach and penetration (superficial slashes and thrusts), although the knife is kept well hidden. It is thereby useful for surprise attacks.

The ideal distance: hand to hand combat area.

Palm Job:



Photo 12

Characteristics: The knife is hidden in the hand (this is only possible with a smaller knife) with its pommel resting on the palm and the thumb supports it (Photo 13). It is a grip with limited use, having sneakiness as its main advantage.

The ideal distance: hand to hand combat area.

Ice Photok:

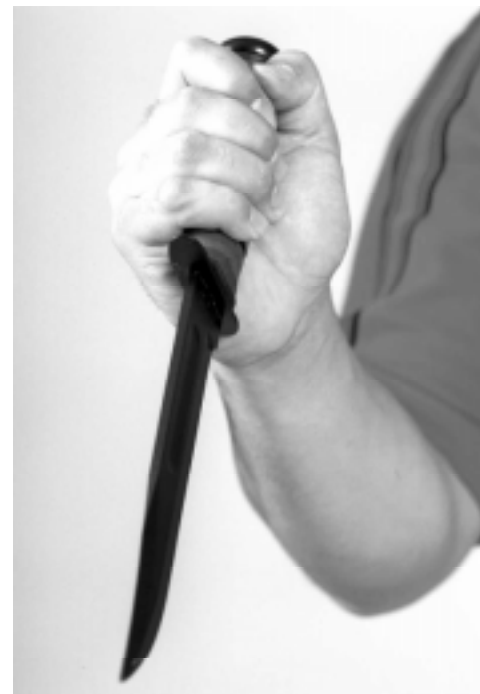
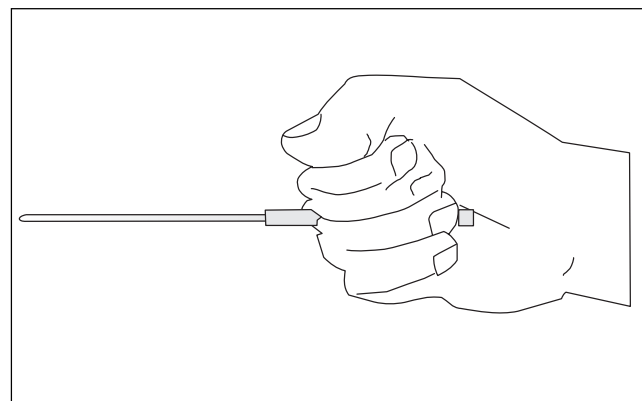

Photo 13



Photo 14



Combat Stances

There are many different stances which can be adopted. They vary according to one's training or preferred martial art style. A good stance will allow the combatant more mobility, stability, and efficiency while decreasing vulnerability. Most martial arts use basic stances which do not allow for good mobility during combat. Mobility is especially crucial in a knife fight where the agility to move in and out is essential to win the combat.

Characteristics: The knife is held just like in the reverse grip but with its edge turned inwards, towards the arm (Photo 14 and 15). It is a grip which allows for thrusts as its main attacks, especially from above the head. It allows for a more powerful attack, but at closer distances only. It has limited use for slashing.

The ideal distance: hand to hand combat area.

The Allen Wrench or Corkscrew Grip:

Characteristics: The knife is supported on the palm and the shaft of the weapon sticks out between the fingers, which are firmly closed to keep it stable (fig 36). This grip requires a specific kind of knife, as the name of the grip implies.

The ideal distance: hand to hand combat area.



Photo 16

Classical stance used by traditional martial arts, decreasing mobility and speed in combat (Phototure 16).



Basic Stance - with the weapon in the front hand.



Photo 17

Characteristics: the knife is located ahead of the fighter, both knees are slightly bent. The body is at an angle, presenting a smaller target (Photos 17 and 18). The free hand protects the neck (high guard); the forearm and elbow protect the heart, lungs and waist line. This is the ideal stance for a knife against knife combat. With the weapon in front one will have farther reach and it also will be a good first line defense, cutting off the opponent's attack. The shoulders must be relaxed, and the body weight should be slightly towards the front leg. The back leg's ankle should be slightly raised allowing for a fast explosive attack (spring effect). It's important to note that by leaving your weight on the front leg it becomes easier to defend attacks against the front leg. The free hand must be ready to block, grab, pass or counter attack as the opportunities present themselves. We must always keep the knife in movement to make it more difficult for the opponent to attack it. This is a fundamental action.

Stance with weapon backward:



Photo 18



Photo 19



Photo 20

Characteristics: The free hand is forward with the weapon held behind it. Both knees are kept slightly bent. The body is at an angle to present a smaller target. Some schools think that leaving the weak hand forward has the benefits of protecting the fighter from getting disarmed. They also think it allows for a better control of the distance therefore improving the efficiency of the attacks. In a knife against knife scenario, this is a stance that should be avoided, as it is easy for the opponent to cut the free hand. This stance is advisable against an unarmed opponent and also when having a shield on the weaker hand. This stance is similar to the military knife combat stance but the arm is not on the horizontal position and the back leg is lighter on the ground.

Military Knife Combat Stance:

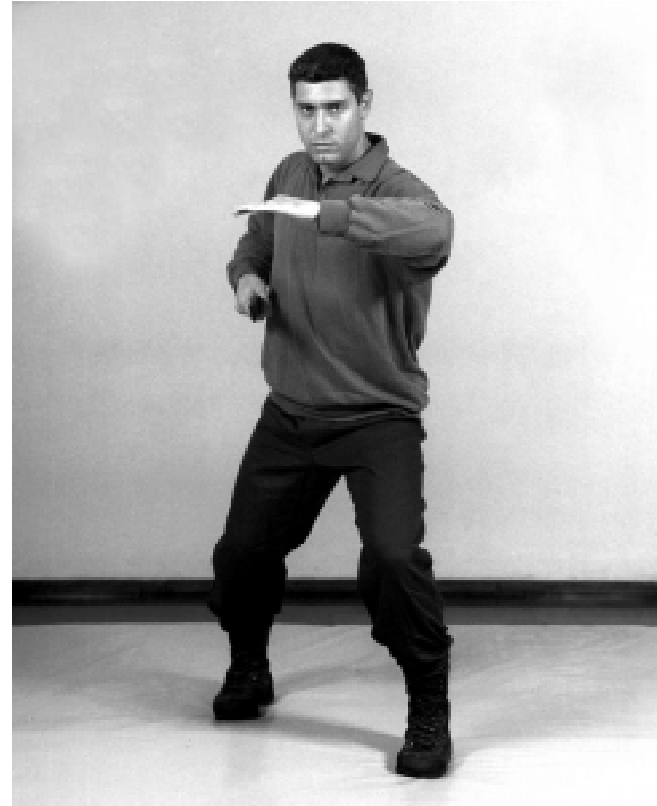

Photo 21

Characteristics: The weaker hand is forward parallel to the ground, the weapon hand is backward and the body is almost square to the opponent with the knees slightly bent. By leaving the weapon hand backward low on the stomach line, the fighter will have a good amplitude of movement but it will take longer to reach a target when attacking. The weak hand in front is supposed to work as a shield but this positioning allows the experienced opponent to slash it with ease.

Sneaky Stance:

This grip is commonly used to hide the knife from the opponent. The knife is held in the reverse grip with its blade hidden behind



the arm (Photo 22 and 23). Another option is to have it forward and cross the arms hiding it (Photo 24 and 25).

Characteristics: The knife, being quiet and easily hidden, is the ideal weapon to use for

ambushes and for surprise attacks. The opponent will never know what hit him. It is very important to be aware of that to avoid being surprised by such attacks.



Photo 22



Photo 23



Photo 24



Photo 25

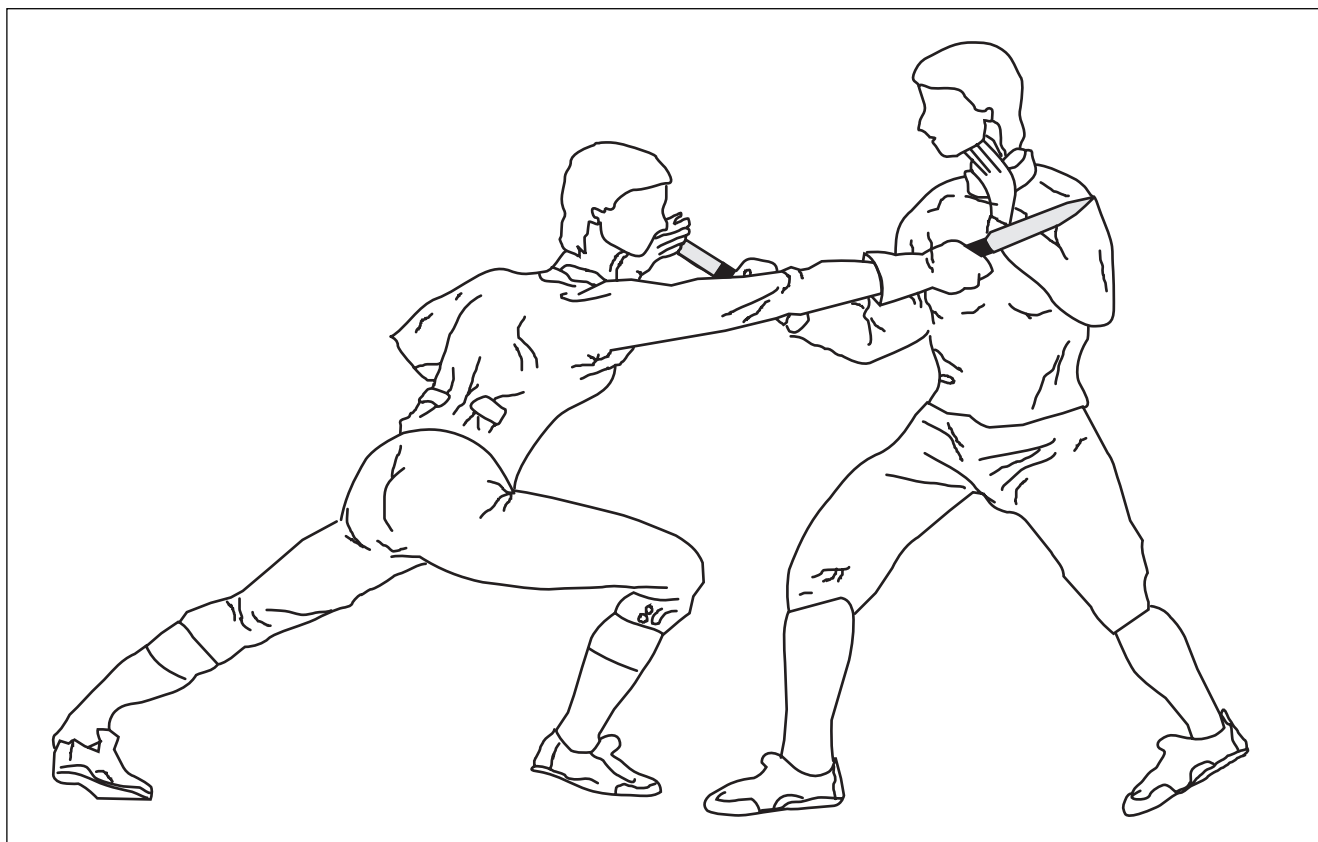

Figure 37

The Carry and Draw

Carry: In order to decide where to carry your knife is necessary to establish some priorities:

Purpose - In the military the knife can be carried openly with its sheath hung on the belt or webbing shoulder strap. For urban use there are many law restrictions, which will vary from state to state, but usually the size is limited and concealment is forbidden.

Design - The weight, size and type must also be considered. A heavy knife can be uncomfortable, a large knife can be difficult to hide, while a folding knife can be carried in most pockets, etc. Most tactical folders have

clips to allow easy draw when carried in pockets. The carrier position - To have a folding knife in your pocket when you are sitting is not going to allow a quick draw. You will be similarly impeded carrying a knife on your back when you are against the wall.

Clothing type - If you are wearing a jacket, an armpit sheath might be excellent but if it is hot weather it might be better to carry it in your pocket or under the belt.

Need - In situations where danger is present, the ideal is to have it hidden in your hand. Do not wait until you really need to use the knife to draw it as it might be too late.

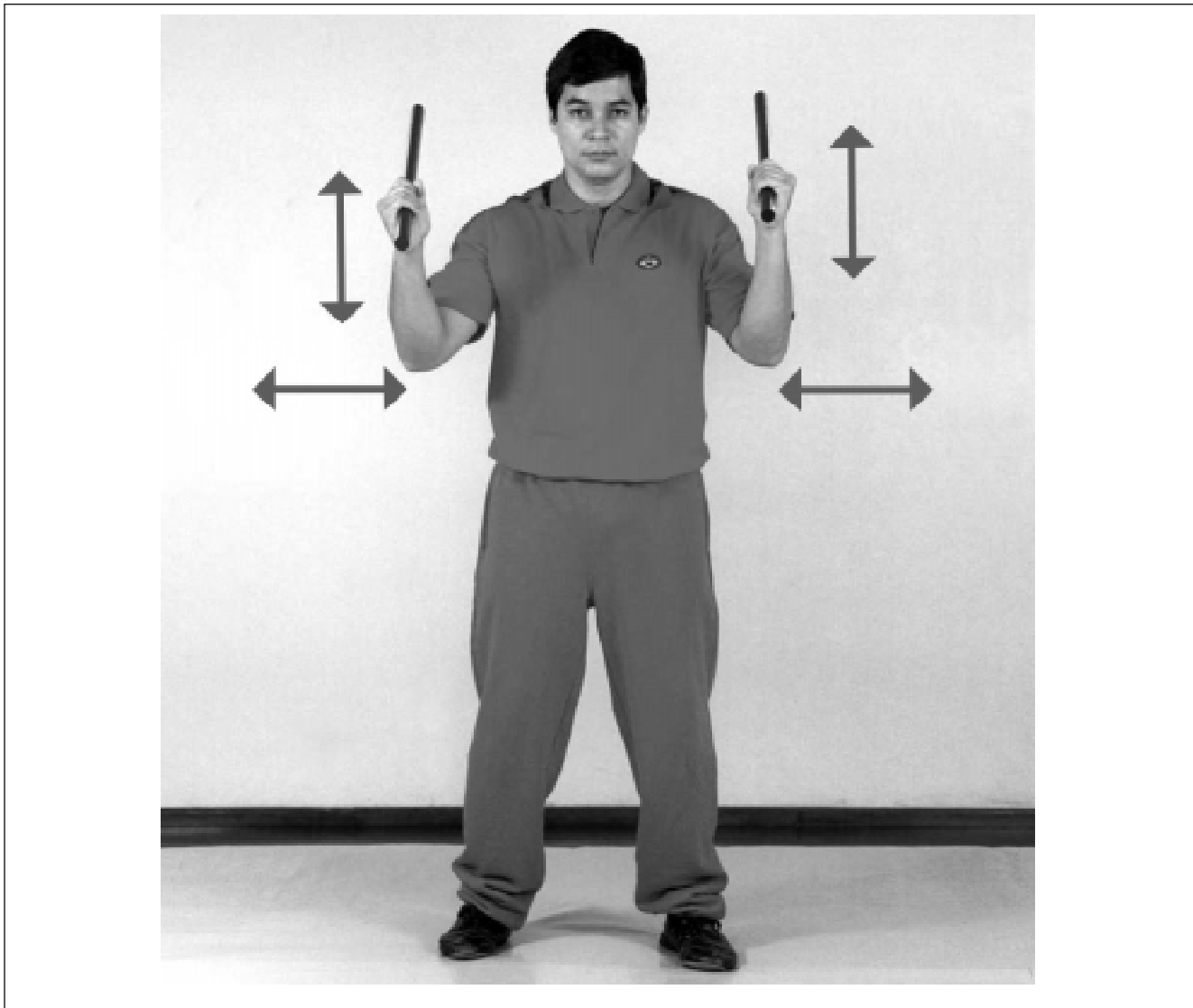

Figure 38

Draw: When drawing some situations must be considered.

Distance - If the opponent is too close he can hold your arm to prevent you from drawing your knife. It is a good idea to use your

weaker hand to block his attempt, or to push him, or to distract him with an attack.

Stages of the draw: Defense of aggressor's attack (Photo 26 and 27), Control of aggressor (Photo 28),





Figure 26

Counter attack and Immobilization.

The knife must be carried in the most natural place to be drawn quickly without warning the opponent of your intentions. As we said before the ideal is to draw it as a precaution not as a reaction.

Combination of attacks (Photos 29 and 30)
- Only one attack is rarely enough to put an opponent out of combat. A sequence will increase your chances of doing it quickly.

Warming Up

It is ideal that the combatant be a complete fighter, who works not only on combative

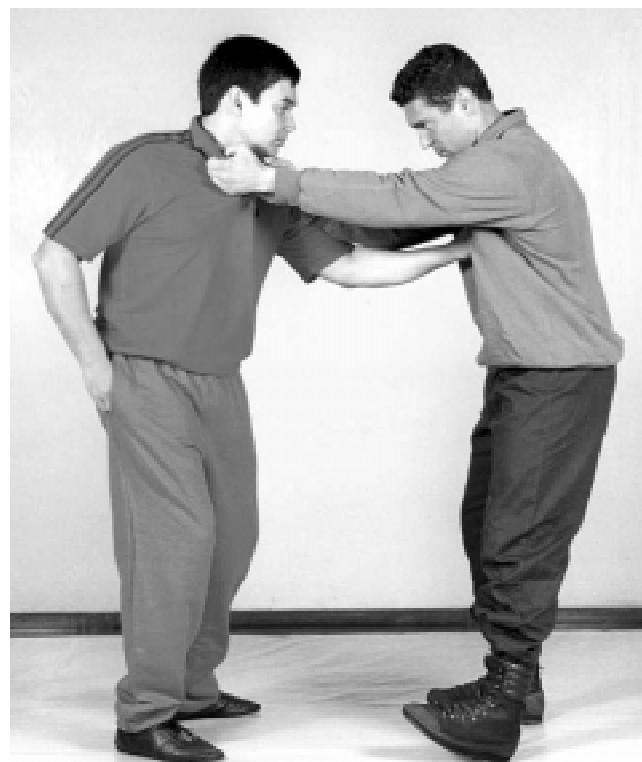

Figure 27



Figure 28

techniques but also on his/ her fitness to be able to survive the efforts and stress real combat demands. The following exercises do not have the intention of working on the overall fitness but only on the specific demands of a knife combat. They will work on grip, speed,



✎ Bloody Brazilian Knife Fighting' Techniques ✎

flexibility, and power of the wrist, arms and shoulders. You will need two sticks that should be 60cm or 70cm long.

2 sticks doing side circular movement forward (Photo 31) 2 sticks doing side circular movement backward (Photo 32)



Photo 29



Photo 30

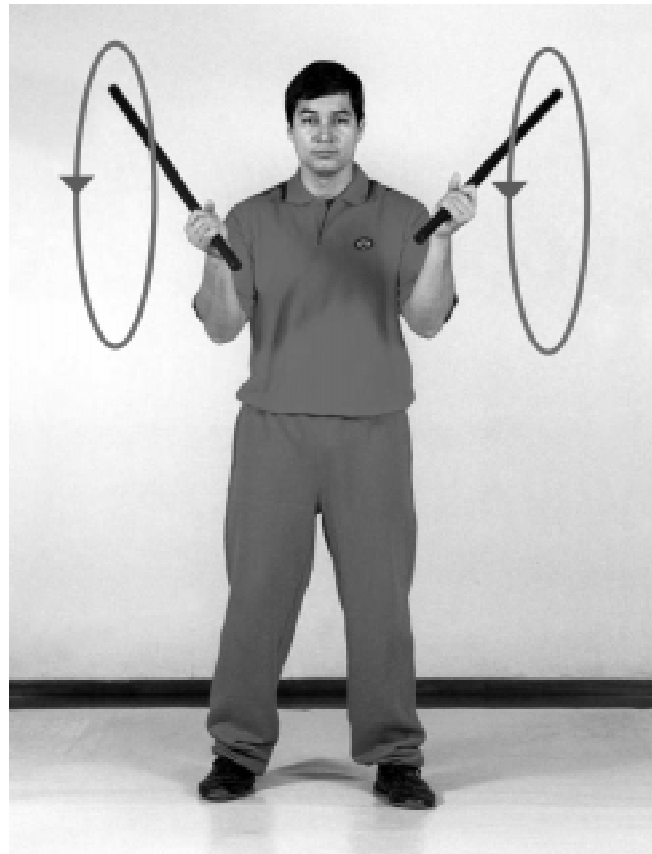

Photo 31

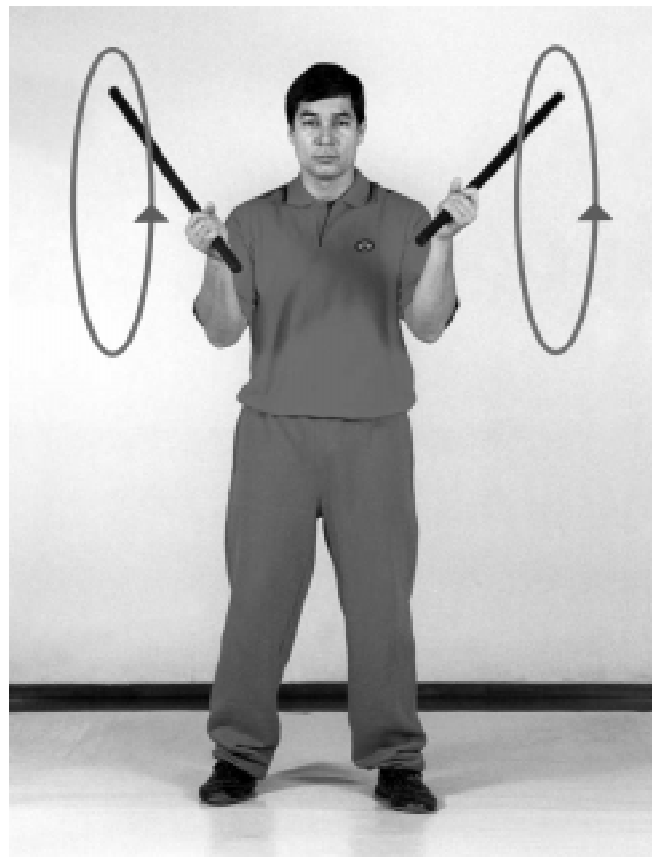

Photo 32



← Bloody Brazilian Knife Fighting' Techniques →

2 sticks doing side circular movement alternating directions (Photo 33) 2 sticks doing vertical simultaneous movement (Photo 34)

2 sticks doing vertical alternated movement (Photo 35 and 36)

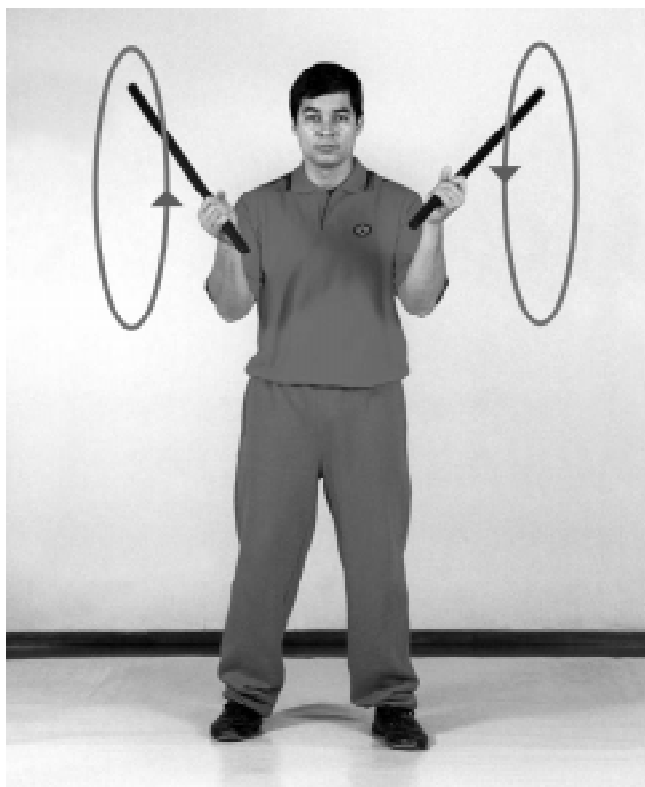

Photo 33

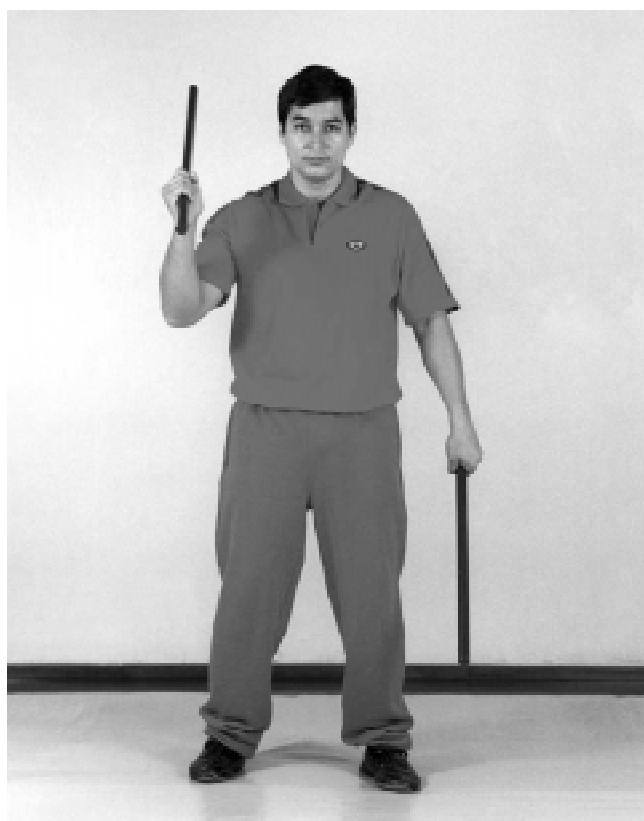

Photo 35

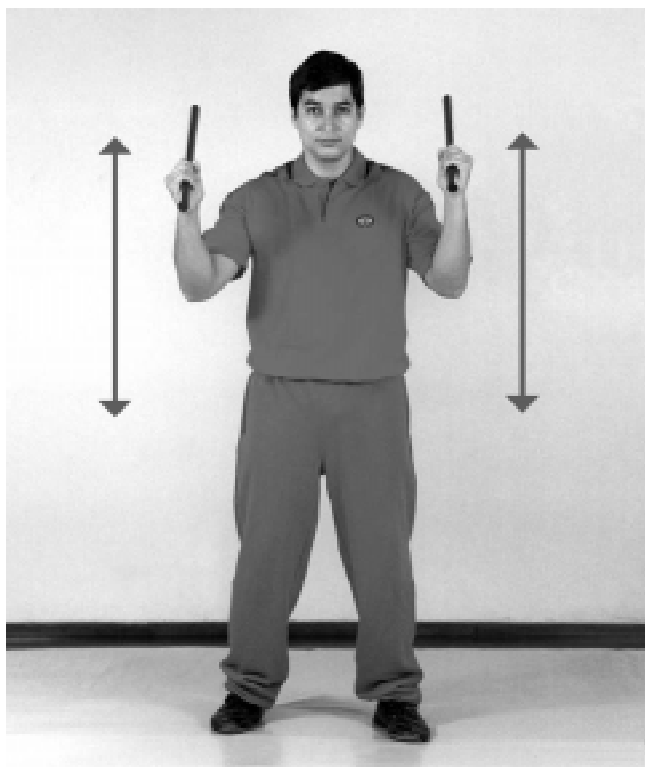

Photo 34

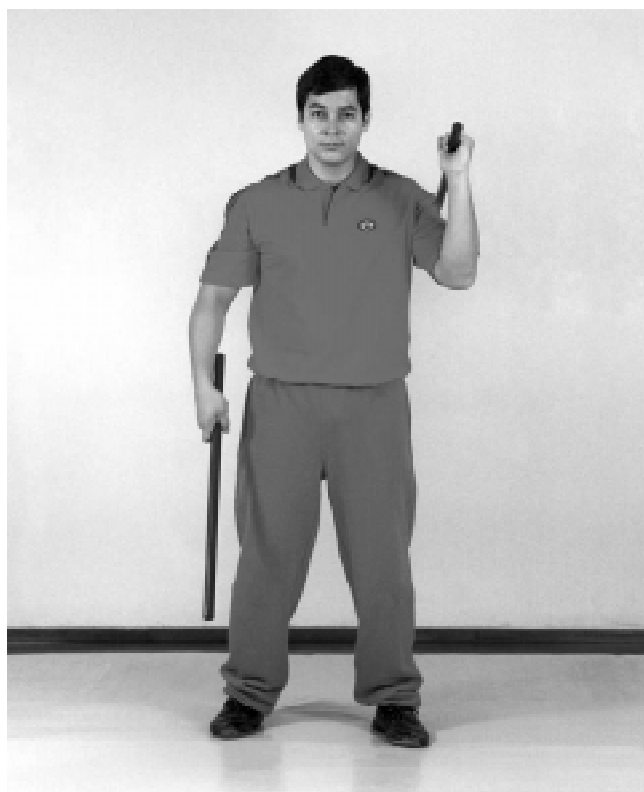

Photo 36



✍ Bloody Brazilian Knife Fighting' Techniques ✍

2 sticks alternating horizontal and vertical movement (Photo 37 and 38)

2 sticks doing the figure 8 movement, both directions (Photo 39 and 40).

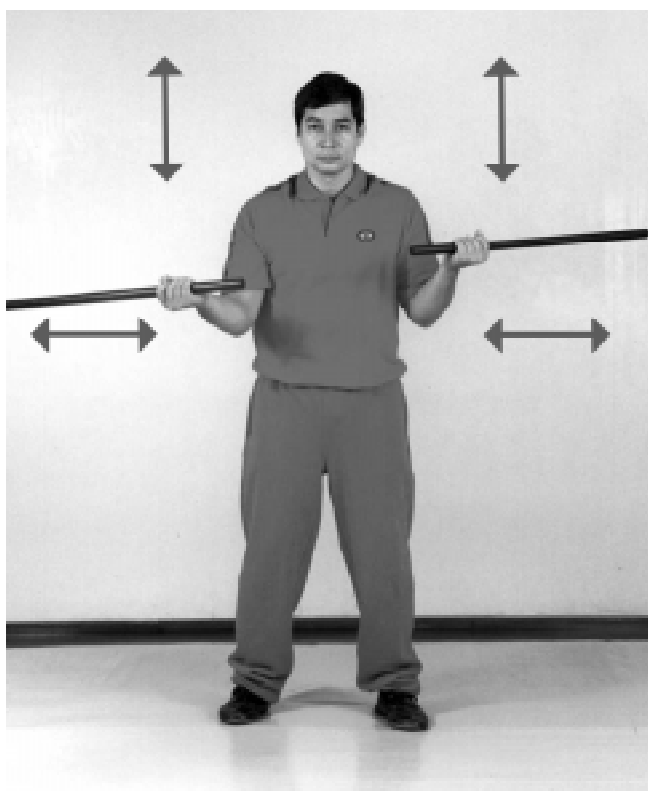

Photo 37



Photo 39

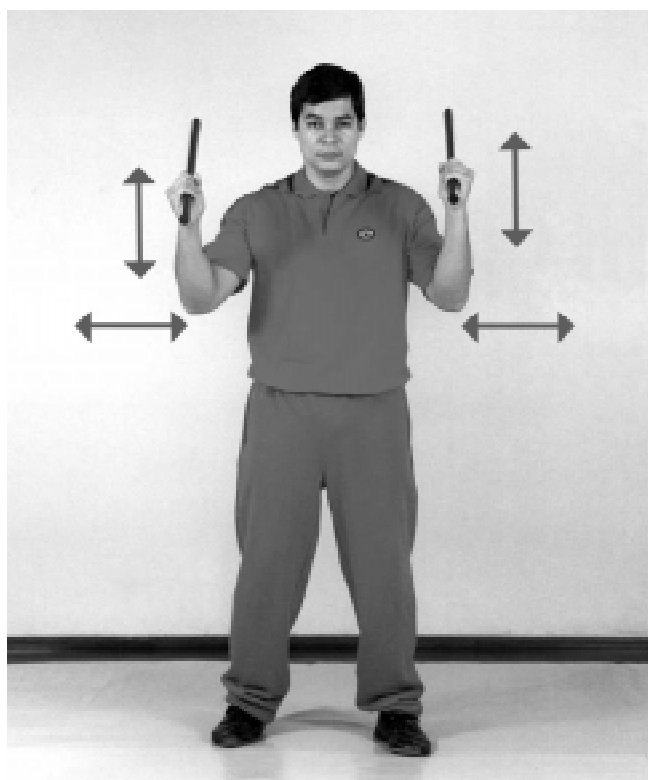

Photo 38



Photo 40



Abaniko - move with sudden changes of direction (on the wrist) with the intention of making it difficult for your opponent to defend attacks.

If your sticks are heavy, they will give you a better workout than if they are made

of foam or balsa wood. Use a material which makes your arms feel the workout, and then move on to heavier objects. This small workout is NOT training, but it will add strength to the muscles crucial to controlling a knife.



Photo 41

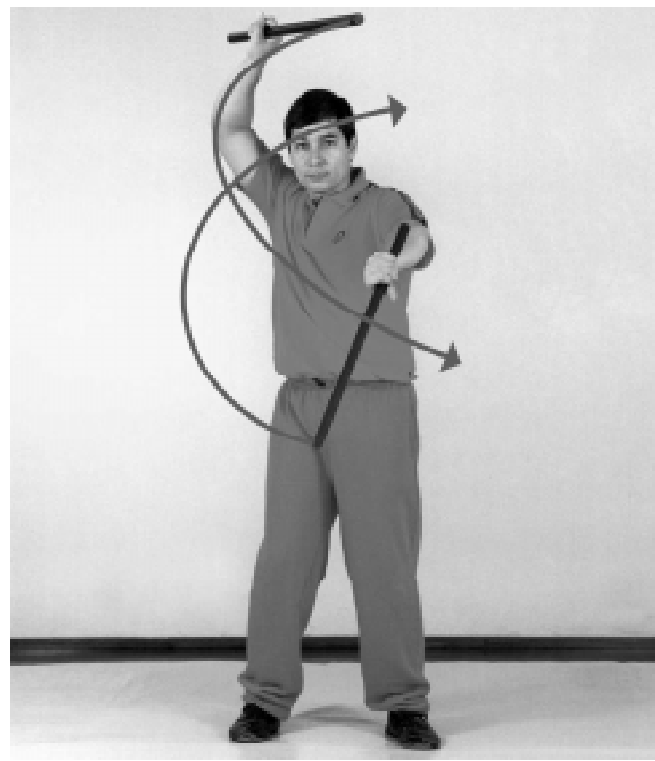

Photo 42

Foot work

Good footwork reflects the skills of a good fighter as it is what gives him mobility, and

subsequent capacity for attack and defense. Footwork is the key to allowing him/ her to finish the combat quickly.

Half Step Forward:

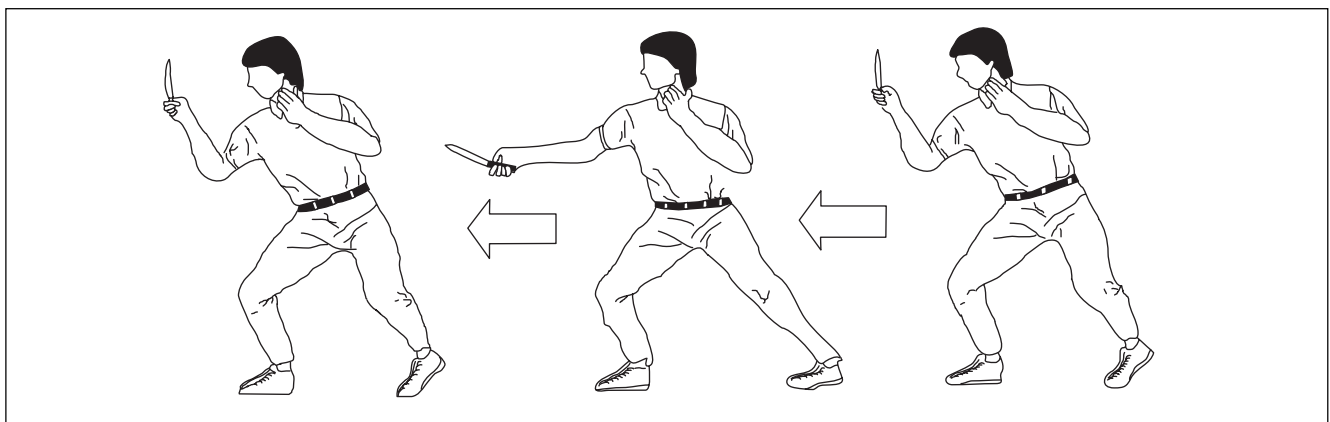

Figure 39





Characteristic - From the basic stance, the fighter advances the front leg's weight slightly forward, with a small step, in a very fast move followed immediately by the back leg returning to the original stance, with the goal of closing small distances quickly. This is the most

important step as it is the most used during combat due to its capacity of allowing fast and unexpected attacks. Usually the strong hand works in synchrony with the legs but sometimes it explodes first.

Half Step Backward:



Photo 43 - Back leg retreats



Photo 44 - Front leg retreats



Photo 45 - Return to original stance

Characteristic - From the Basic stance the fighter initially pulls back the back leg, with a small fast step following immediately with the front leg, returning to the original stance. Its

main goal is to do a fast retreat gaining space for a counter strike, which many times is done simultaneously with it.

Complete advance:

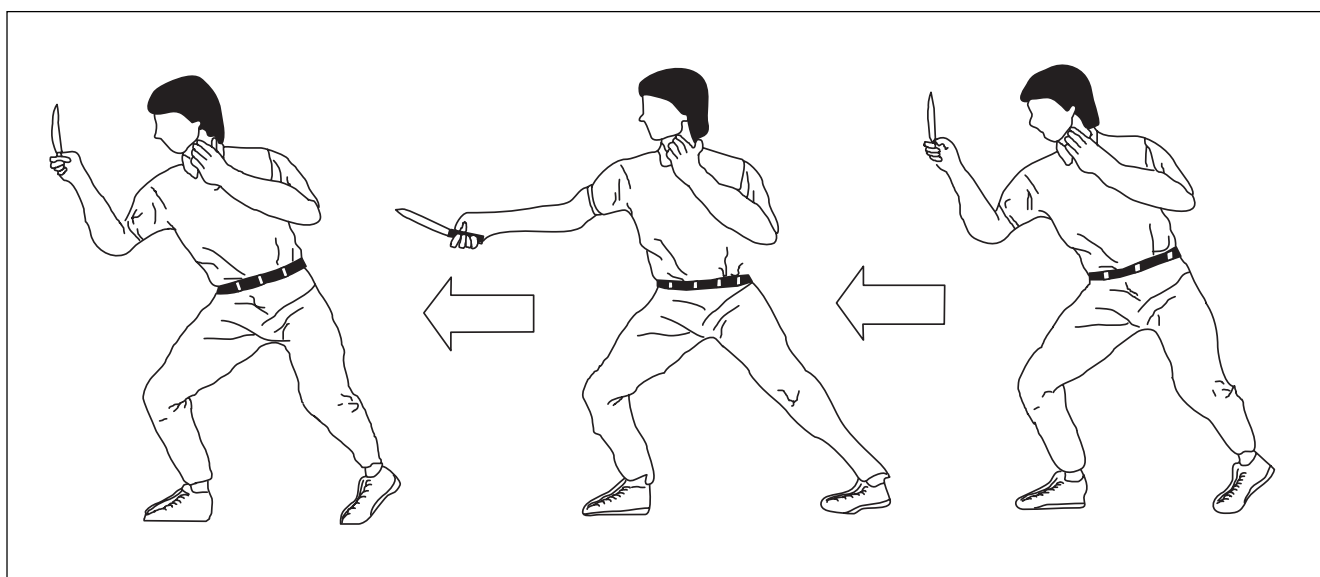

Figure 40

Characteristic - From the Basic stance the fighter goes a full step forward. Its goal is to close in the distance from the risk area to the primary

combat area. It's slower than the half step, and shows to the opponent your intentions, therefore it should be avoided on a direct attack.





Complete Retreat:

Characteristic - From the basic stance the fighter gives a full step backward changing weapon hands. The ideal movement is to perform at least two steps to return the knife to

the strong hand ending on the original stance. Its goal is to achieve a good distance in order to avoid the opponent's attack. This move establishes a defensive strategy to the combat. Avoid turning your back to your opponent while retreating, as you will be an easy target.

Changing combat stance:

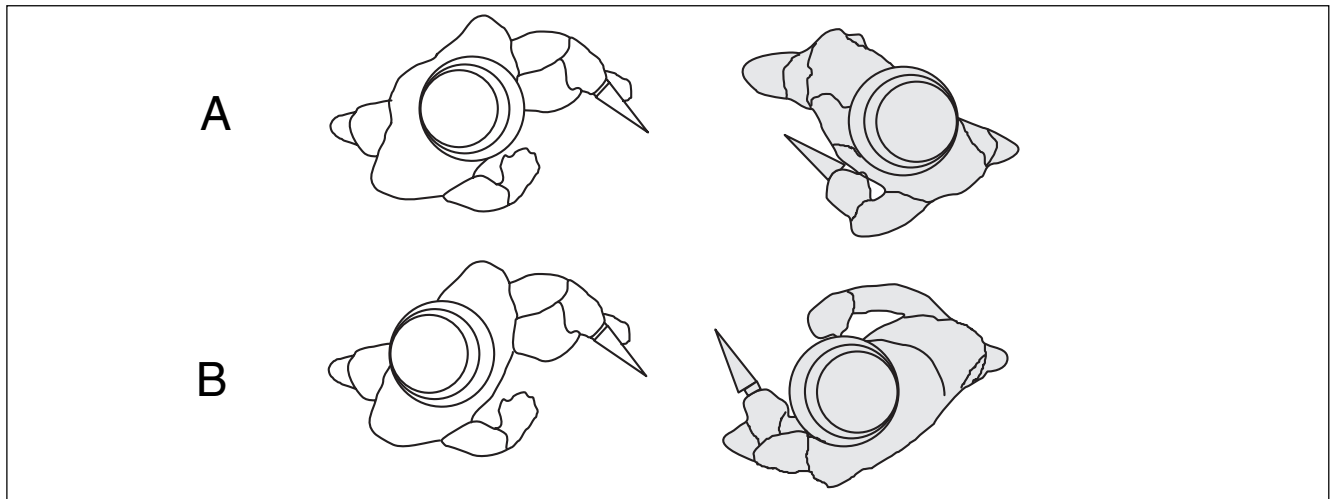

Figure 41

Characteristics - From the basic stance there is a quick change of stances from the strong hand forward to strong hand backward. Its goal is to

distract the opponent or to change your attacking and defending focus. This change of stances allows for a great number of variations.

Triangulation:

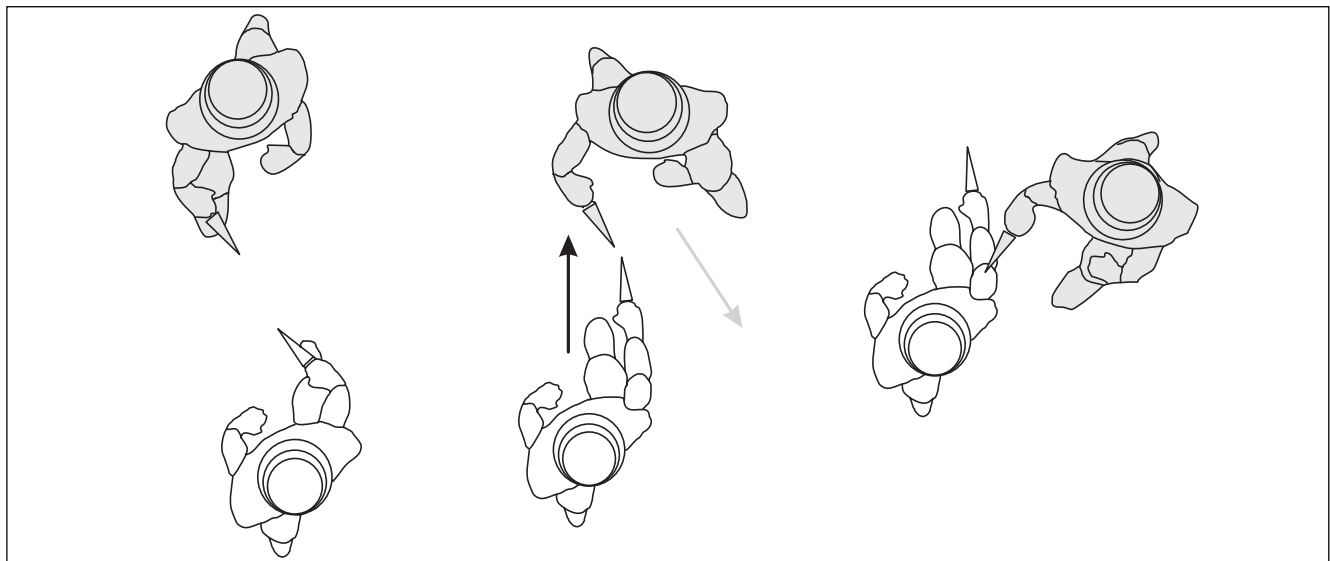

Figure 42





✍ Bloody Brazilian Knife Fighting' Techniques ✍

Characteristics - From the basic stance it is possible to execute attacks and defenses with ease, changing the general combat direction from linear to diagonal. The legs should

move on a diagonal direction (45°) going to the left or right. This move can be performed by both feet. It's preferable to move towards the dead side of your opponent (his back).

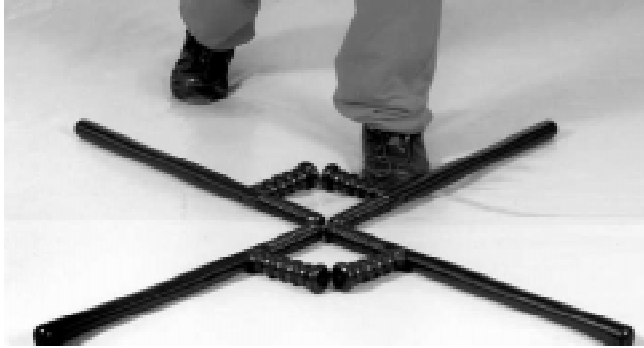

Photo 46



Photo 49



Photo 47



Photo 50



Photo 48



Sideward Stepping:

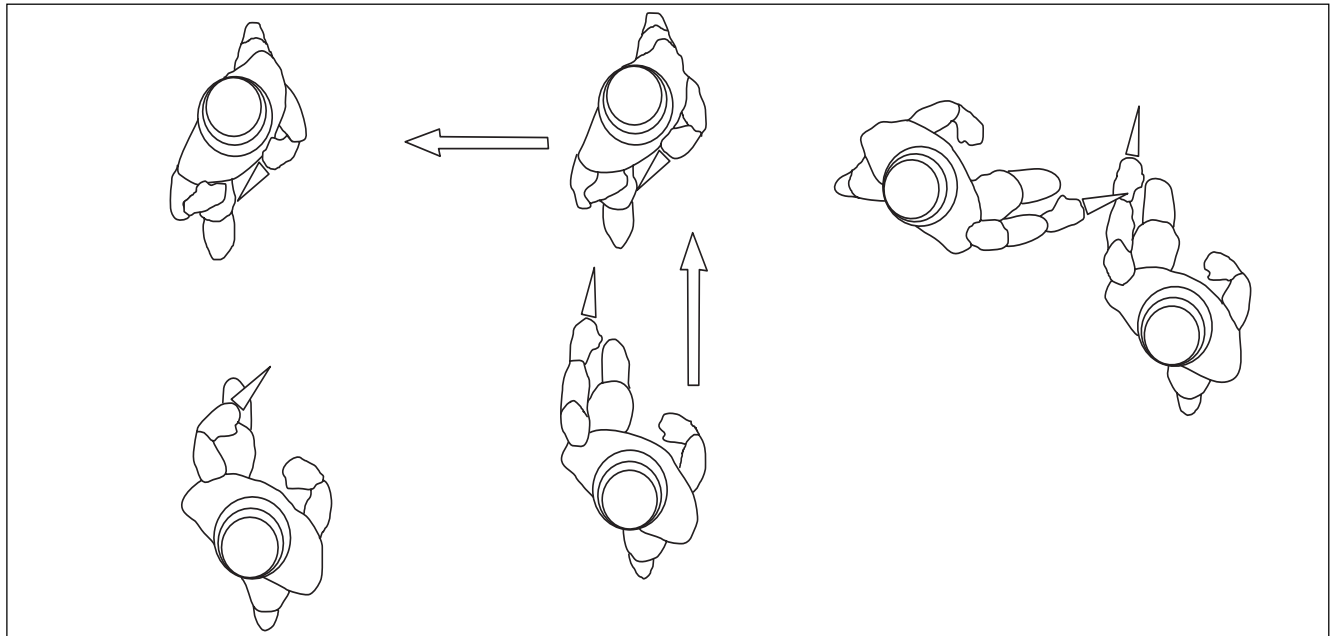

Figure 43

Characteristics - From the basic stance the back leg moves on a 45° angle to the side without moving the front leg. This move also breaks with the linear combat, allowing you to reach your opponent with counter attacks. Always look to move towards your opponents dead side.

a diagonal to the left downward and again from the left to the right downward. This exercise will work on the fluidity of the attacks. Use the Hammer, Saber or Floret grip.

Execution: Start the exercise slowly paying attention to the direction of the cut and being edge aware. Accelerate it gradually always maintaining it flowing in a continuous movement.

Basic Techniques - Solo work

The following exercises are very important for learning the basic techniques as they develop fluidity, agility and control over the tool making them natural and instinctive moves. The constant use of the knife decreases the natural fear we all have for knives and at the same time makes one be more at ease with the idea of using it in combat.

Cutting Techniques:

Exercise 1 - Figure Eight

Characteristic - 2 cuts forming an X starting from the right (if right handed) following

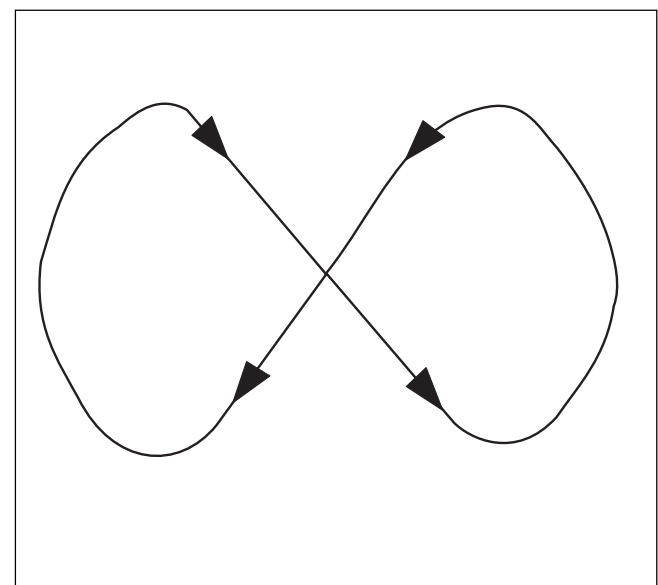

Figure 44



Photo 51

Exercise 2 – Reverse Figure Eight

Characteristic - 2 cuts forming an X starting from the right (if right handed) following a diagonal to the left upward and again from the left to the right upward. This direction of cuts increases the options for attacks and defenses. Use the Hammer, Saber or Floret grip.

Execution: The same as in exercise 1.

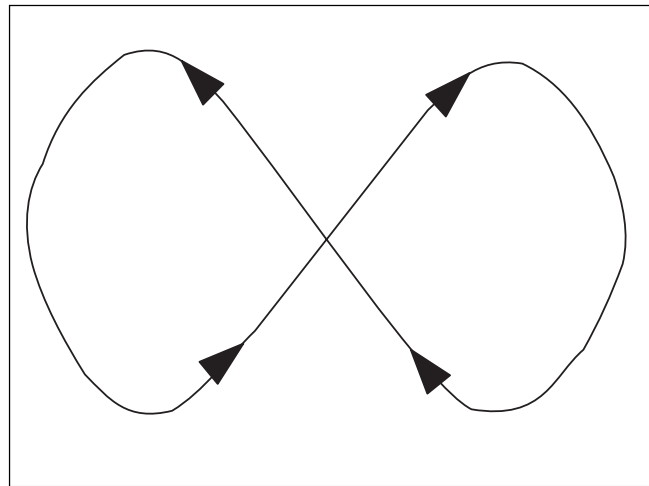

Figure 45



Photo 52

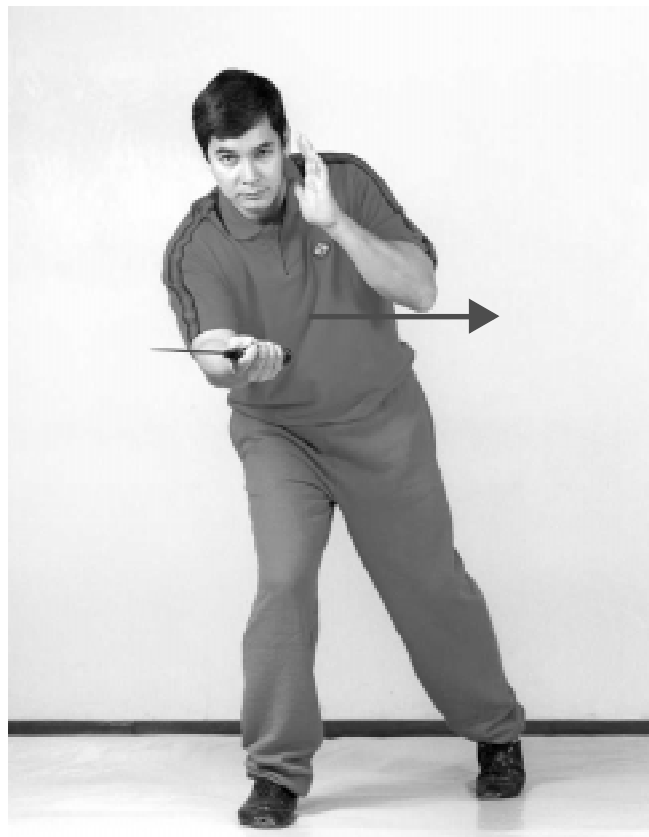

Photo 53



Exercise 3 - Cross

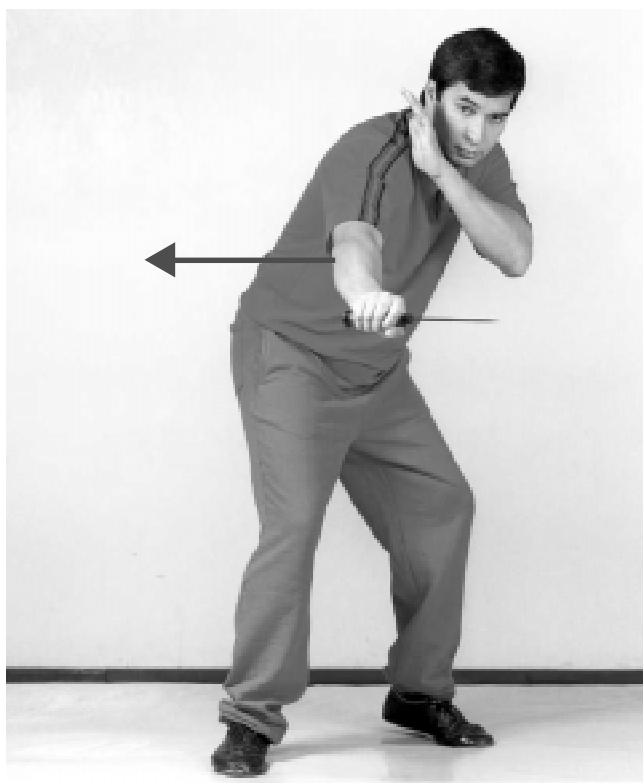

Photo 54



Photo 55

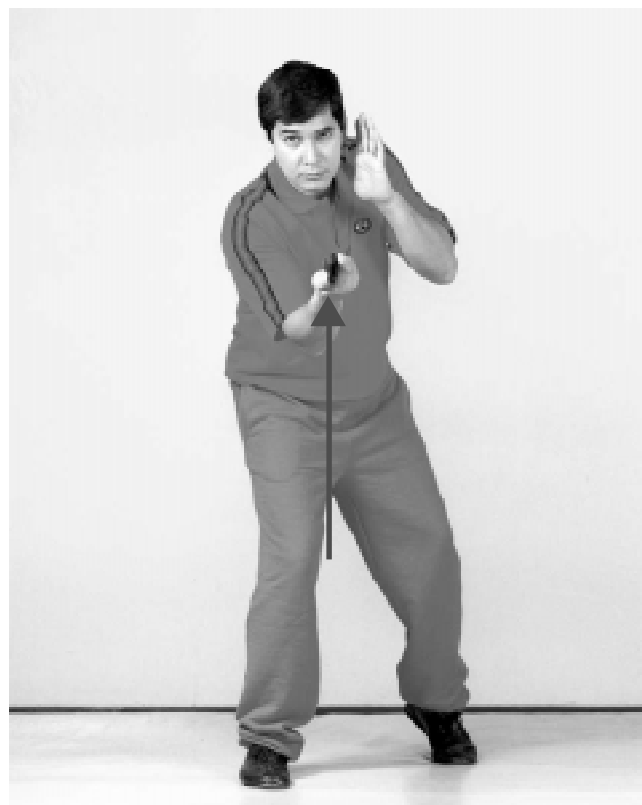

Photo 56

Characteristic - 4 cuts - 2 on the horizontal (Photos 53 and 54) followed by 2 on the vertical (Photos 55 and 56). Start from right to left (if right handed) and repeat the move from left to right. Then cut from up downward and then from down going upward. Use the Hammer, Saber or Floret grip.

Execution: The same as in exercise 1. Start slowly with the movements paying attention to where the knife's edge would be cutting. Then speed up the movements.

Exercise 4 - Asterisk

Characteristic - 6 cuts unifying all the previous exercises. It is important to work the wrist and not only the arm and shoulder. It is a good idea to practice it in front a mirror as you will be able to look for mistakes and correct them. Do not exaggerate on the amplitude of the cuts keeping them tight (cutting only the length of the body) and flowing. Use the Hammer, Saber or Floret grip.



Execution: The same as in the previous exercises. Pay attention to the edge of the knife to make sure that with your movements it is aligned to make contact with your opponent.

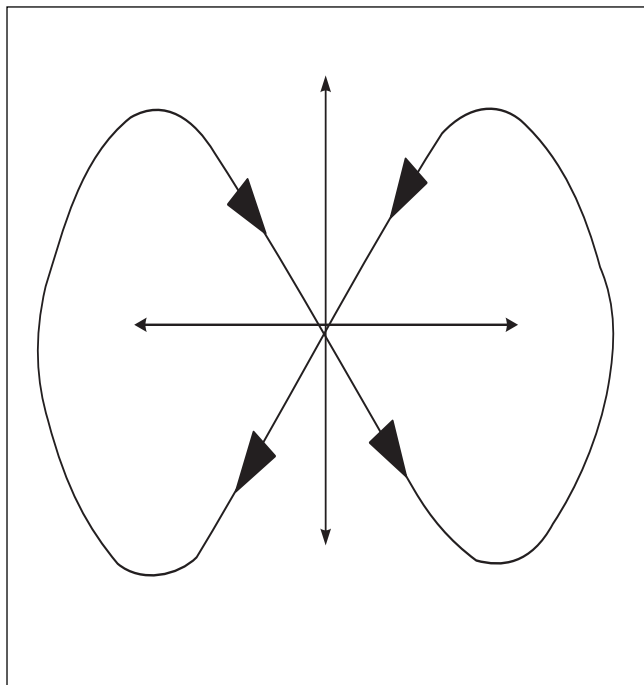

Figure 47

Changing the direction of the cut.

Exercise 5 - Making the "C"

Characteristic - 2 cuts in sequence with a sudden change of direction, increasing the unpredictability of the attack. Its defense is very difficult as we are led to defend the initial attack and are then surprised by the change of direction. Most Martial Arts train to defend against a committed linear attack therefore this sort of attack will almost always be successful

even with the most experienced Martial Artist. Use the Hammer, Saber or Floret grip.

Execution: The same as with the previous exercises. Practice in several different angles as shown below. The attack starts towards the head then changes towards the legs. (Photo 57 and 58)

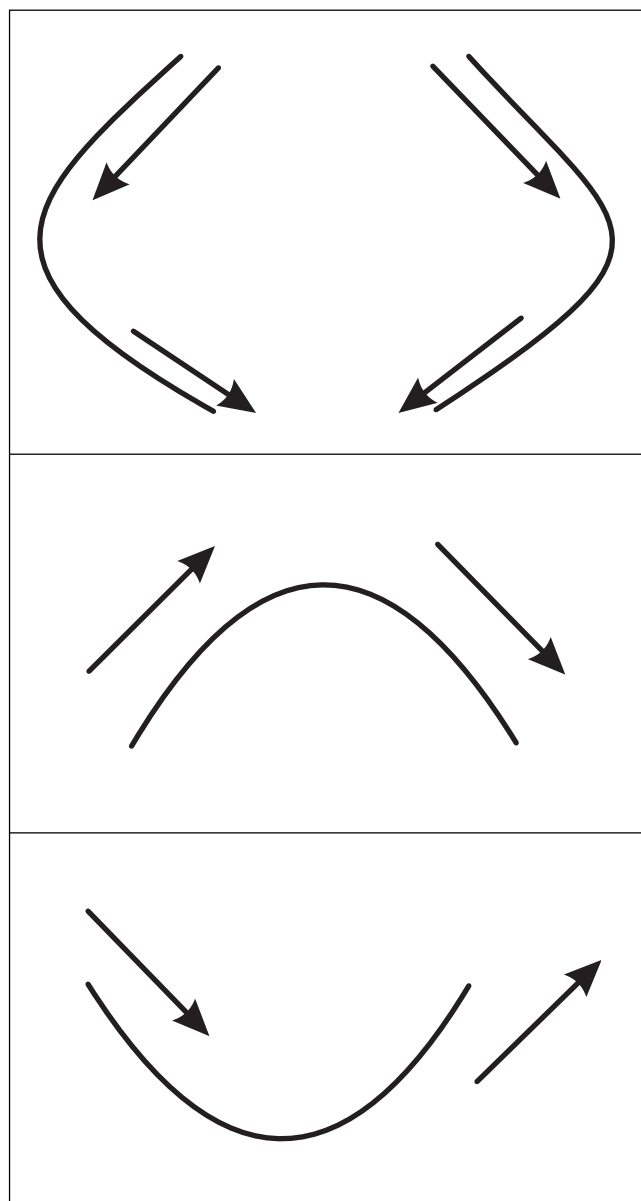

Figure 48

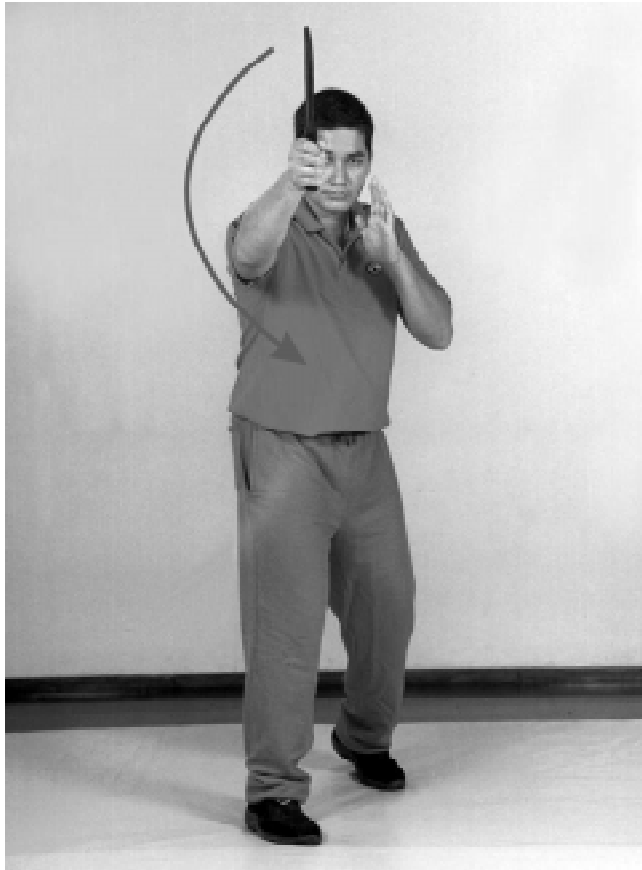

Photo 57

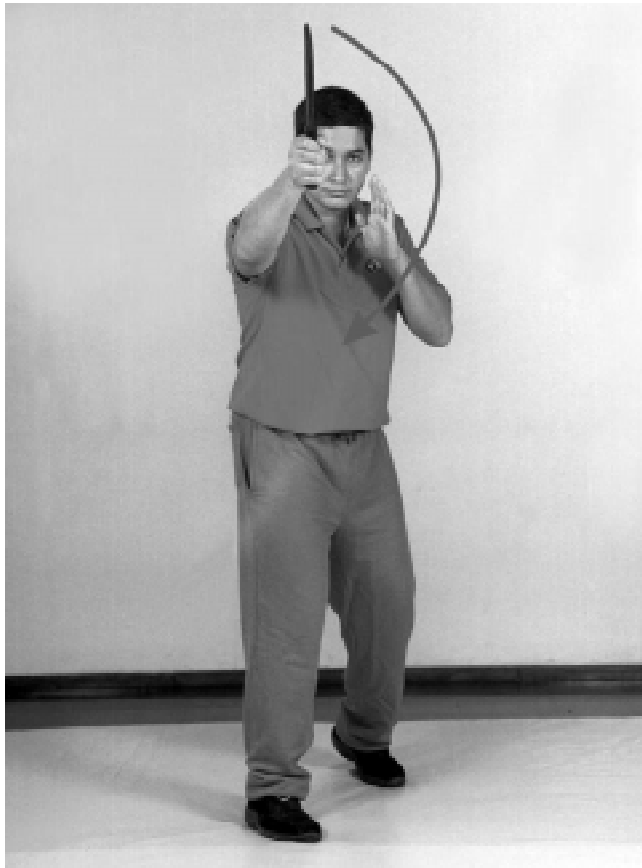

Photo 58

Exercise 6 - Abanniko

Characteristic - The direction of the cut is changed quickly with a wrist twist in an action similar to using a hand fan. This movement also has the unpredictability factor in its favor and can be used for multiple attacks or as defense and counter attack or solely as defense with multiple cuts to the attacking arm.

Execution: Practice 3 different heights - 1) eye level - 2) arm level - 3) legs level.



Photo 59



Photo 60



Exercise 7 - Slapping

Characteristic - Slap your own wrist or forearm to help changing the direction of cuts or thrusts in a fast and powerful way. Use the Hammer, Saber, Floret, reverse or ice-Photok grip.

Execution: Practice 3 different heights - 1) eye level - 2) arm level - 3) legs level.



Photo 61



Photo 62

Exercise 8 - Crossada

Characteristic - Aggressive defensive movement which allows one to defend an attack and cut the attacking arm at the same time. The free hand deflects the attacking arm accelerating its movement towards the knife hand which in turn cuts it.

Execution: Practice the movement on 3 different heights. 1) against an attack from above the head, opening the arms in opposite directions (Photo 63 and 66). 2) against an attack to the eye and stomach, closing the arms in opposite directions.



Photo 63

Photo 64



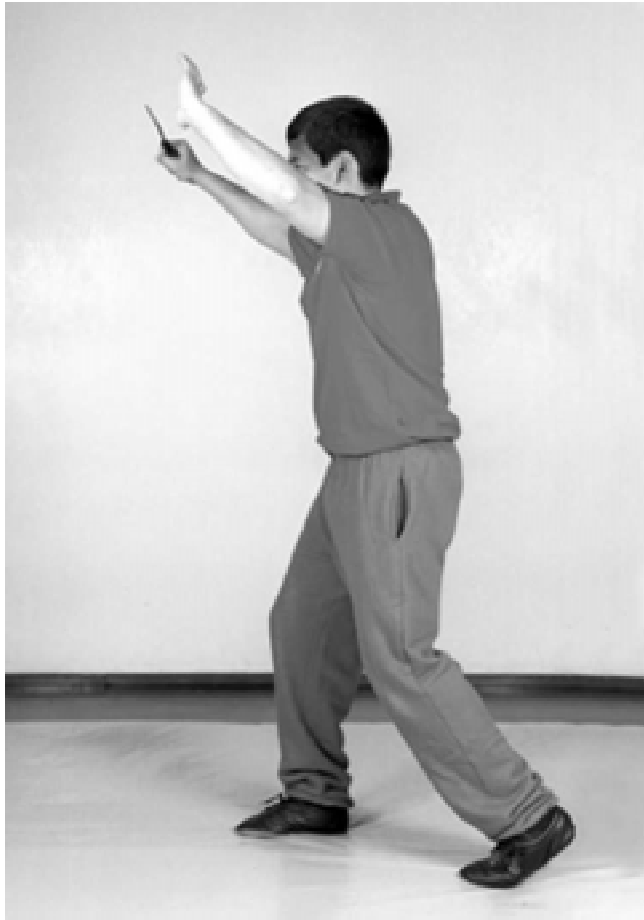

Photo 65

Exercise 9 - Nine angles of thrusts.

Characteristic - 9 thrusts, 4 in diagonal directions, 2 on vertical, 2 on horizontal and one thrust straight to the heart.

Execution: The same as with the previous exercises. Start slowly in front of a mirror.

Watch the attack angle of the blade, and then speed up your movements.



Photo 67

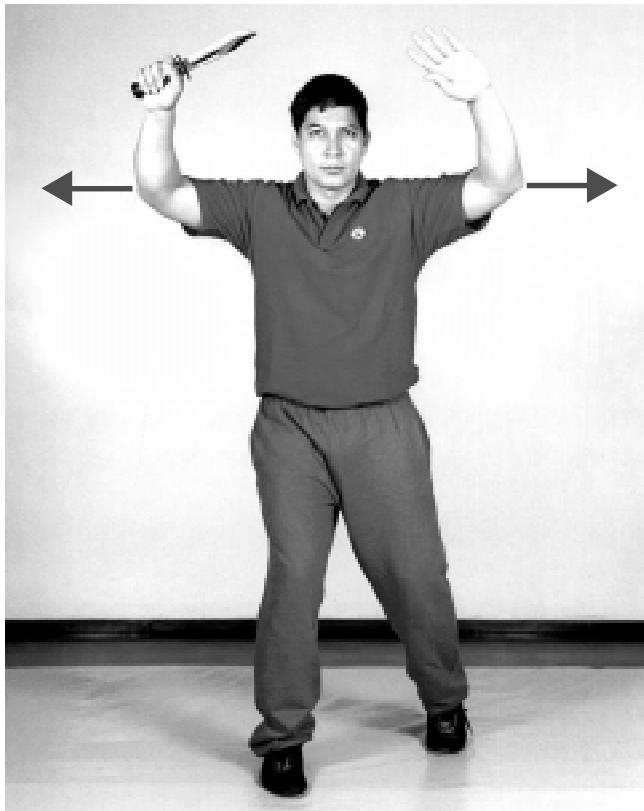

Photo 66



Photo 68





✎ Bloody Brazilian Knife Fighting' Techniques ✎



Photo 69

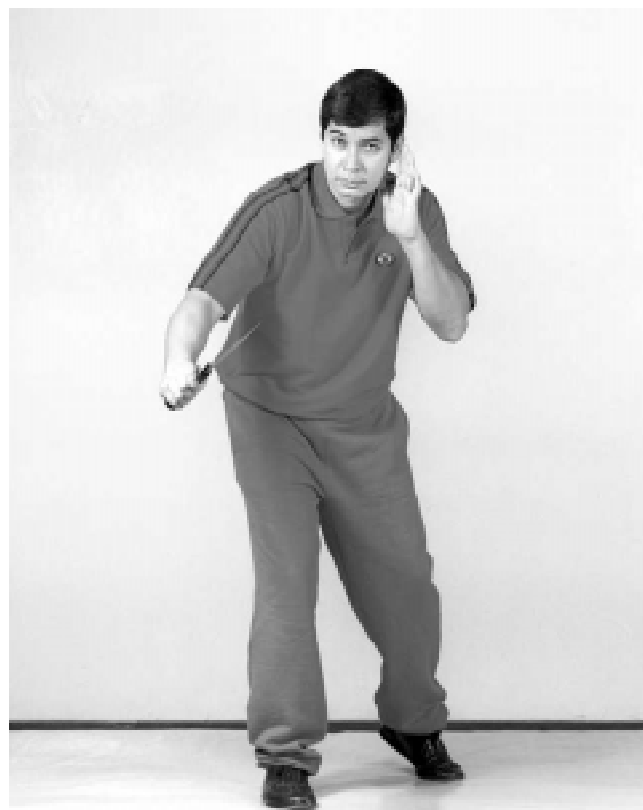

Photo 70



Photo 71



Photo 72



←  Bloody Brazilian Knife Fighting' Techniques  →

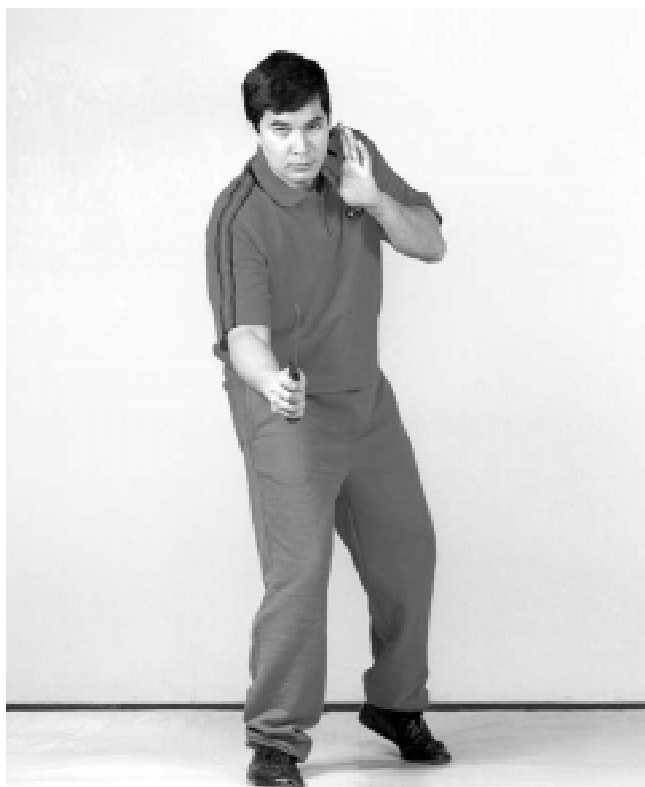

Photo 73



Photo 75

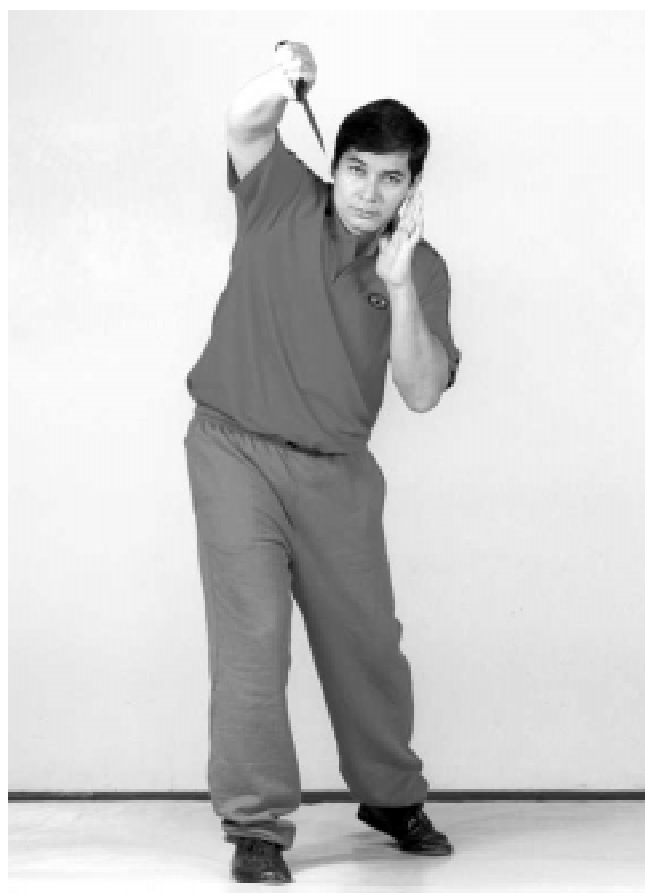

Photo 74

- Photo 67 Superior Right Diagonal
- Photo 68 Superior Left Diagonal
- Photo 69 Right Side
- Photo 70 Left Side
- Photo 71 Inferior Right Diagonal
- Photo 72 Inferior Left Diagonal
- Photo 73 Inferior Central Upward
- Photo 74 Superior Central Downward
- Photo 75 Central (just below Xiphoid process)

Exercise 10 – Thrust with Twist

Characteristic - All thrusts, if possible, should be followed by a quick wrist twist rotating the knife during or after penetration. This move will increase the attack efficiency, increasing the damage, and at the same time it will make the knife easier to withdraw.

Execution: Add the twist to every thrust from the previous exercise.



Photo 76 and 77 - This move increases the damage considerably besides allowing the knife to be withdrawn more easily.



Photo 76



Photo 77

Exercise 11 - Thrust with Cut

Characteristic - The thrust should be followed by a cut. This move increases damage and allows the attacker to quickly change direction for a new attack improving the flow of attacks.

Execution: Add a twist and cut to all angles of exercise 9.

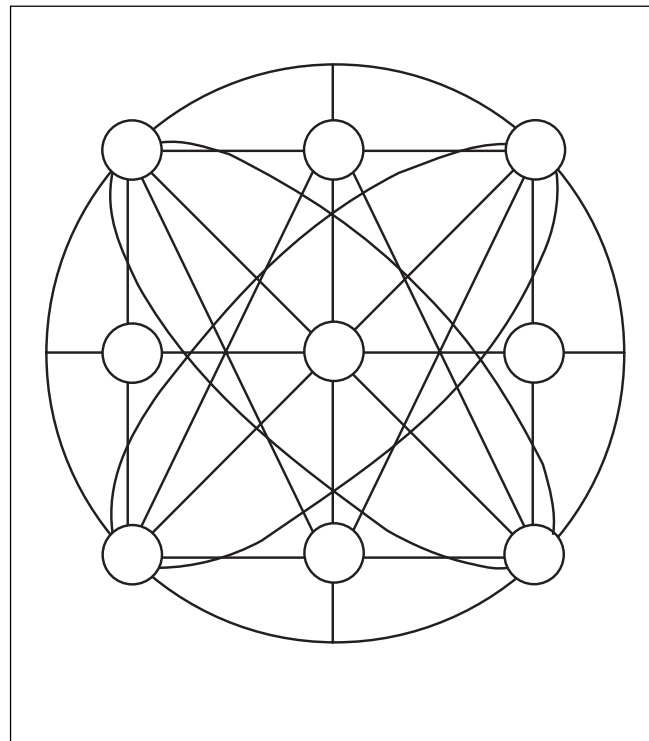

Figure 49

Exercise 12 - Free Training

Characteristic - The practice of these exercises will work on the flow of the moves making them increasingly instinctive and natural. When free training, be creative and work on follow ups for all the attacks keeping a continuous flow of moves.



12 Angles of Attack

The 12 angles of attack are very common in Arnis de Mano, Philippine fighting style. They also work on fluidity and have selected targets to be attacked. There are many variations of exercises that can be done using these angles. The

attacks can be short or long. It is interesting to work both ways but your emphasis should be on short economical and fast attacks, as they are more difficult to defend and provide less opening for counter-attacks. On these exercises we are going to practice cuts and thrusts and as before it is a good idea to do it in front a mirror.

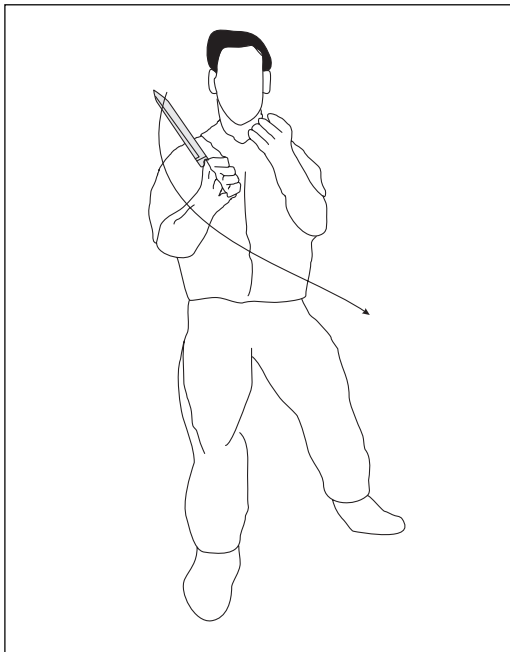

Fig. 50



Photo 78

Angle 1 - Diagonal downward slash from right to left targeting the left side of opponent's neck.

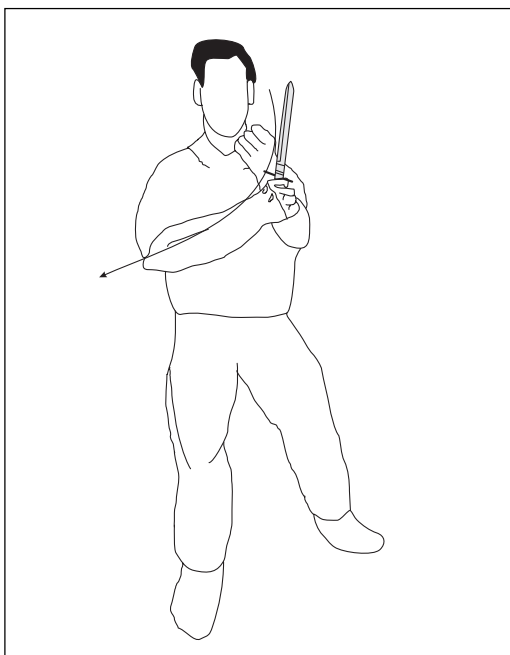

Fig. 51



Photo 79

Angle 2 - Diagonal downward slash from left to right targeting the right side of opponent's neck.





✎ Bloody Brazilian Knife Fighting' Techniques ✎

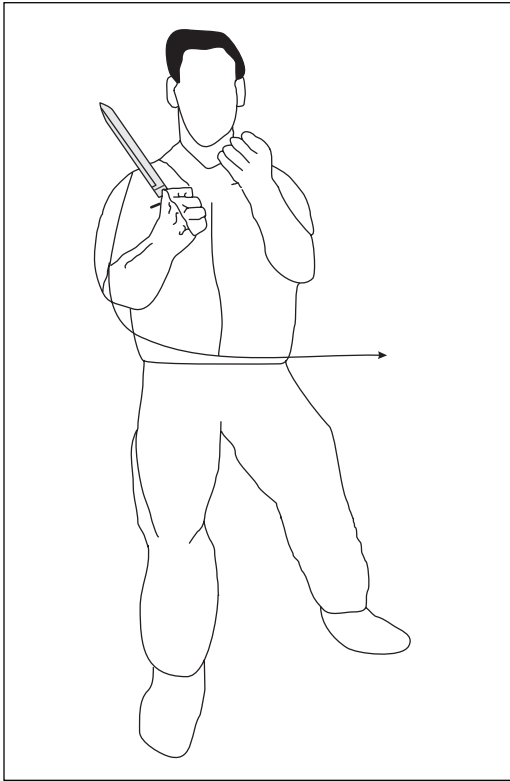

Fig. 52



Photo 80

Angle 3 - Horizontal slash from right to left targeting opponent's left ribs.

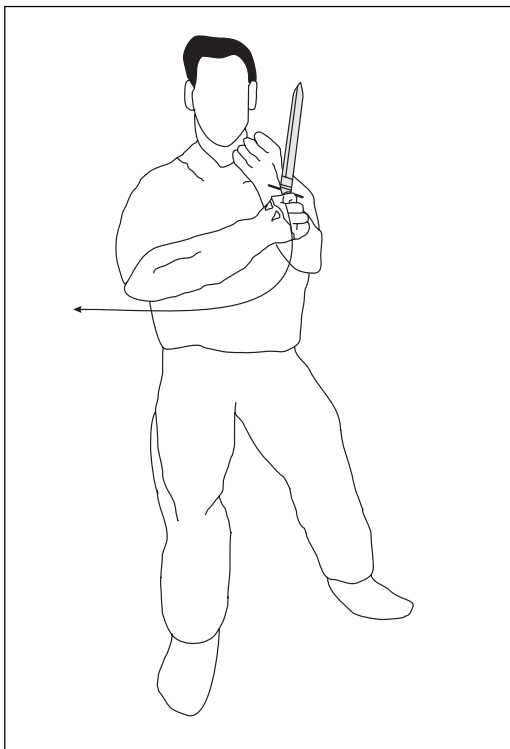

Fig. 53



Photo 81

Angle 4 - Horizontal slash from left to right targeting opponent's right ribs.





✎ Bloody Brazilian Knife Fighting' Techniques ✎

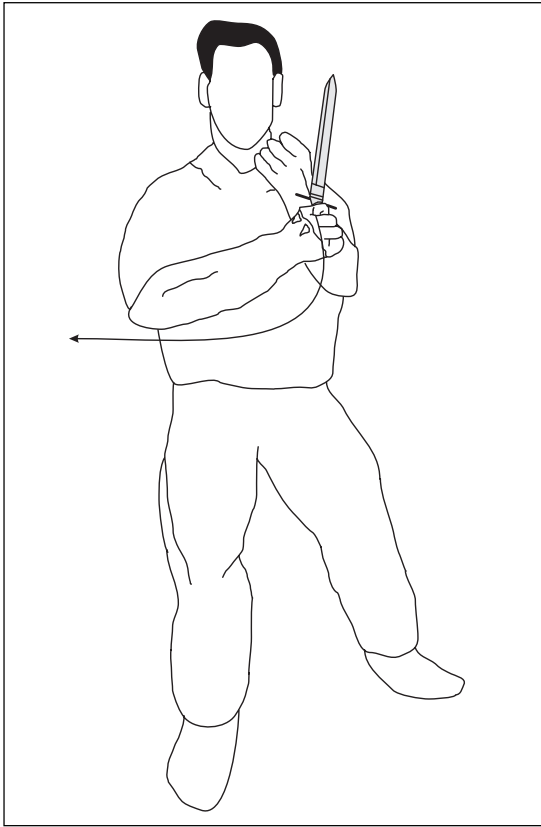

Fig. 53

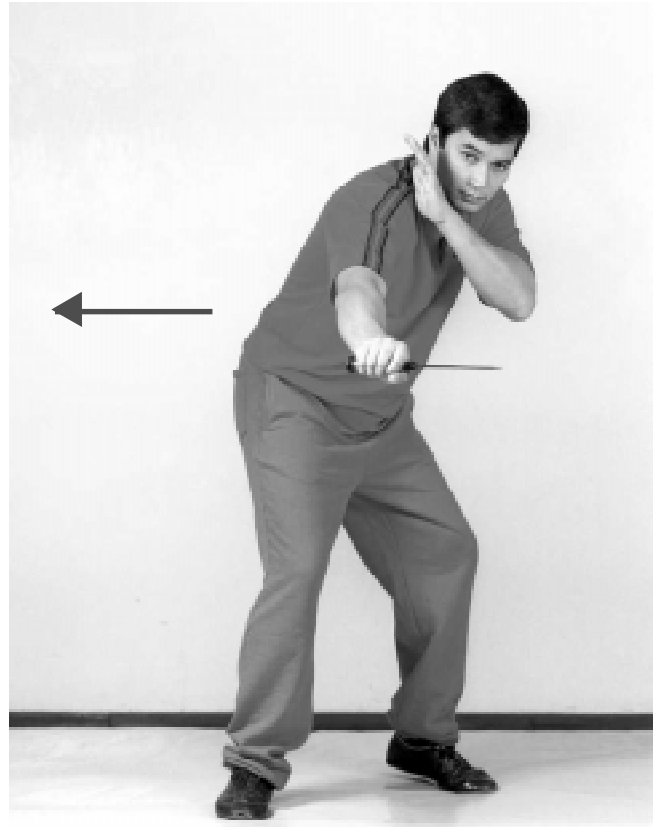

Photo 81

Angle 5 - Straight stab to opponent's central region.

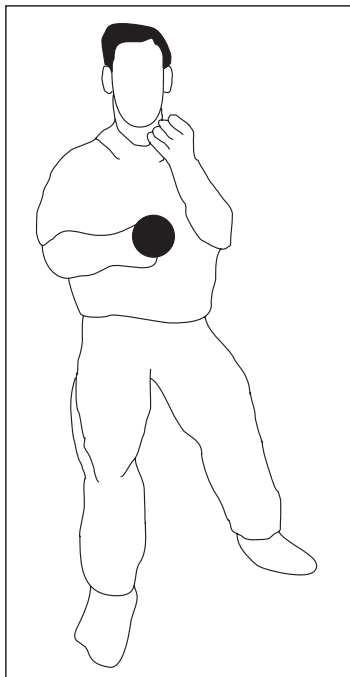

Fig. 54



Photo 82

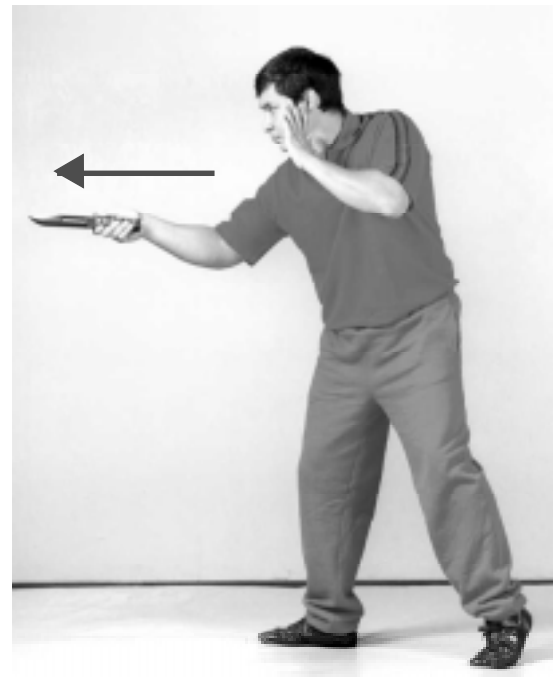

Photo 83

Angle 6 - High straight thrust targeting opponent's left shoulder.





✍ Bloody Brazilian Knife Fighting' Techniques ✍

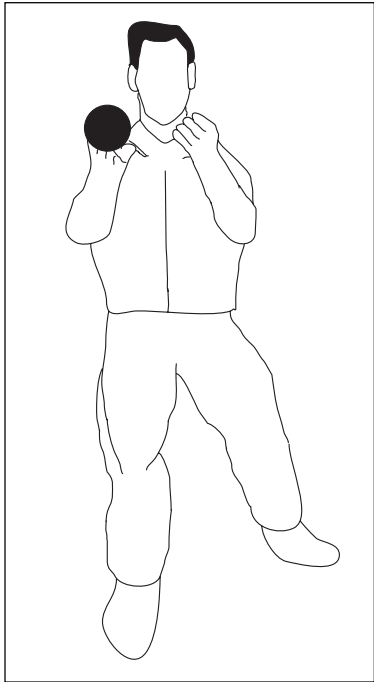

Fig. 55



Photo 84



Photo 85

Angle 7 - High straight thrust targeting opponent's right shoulder.

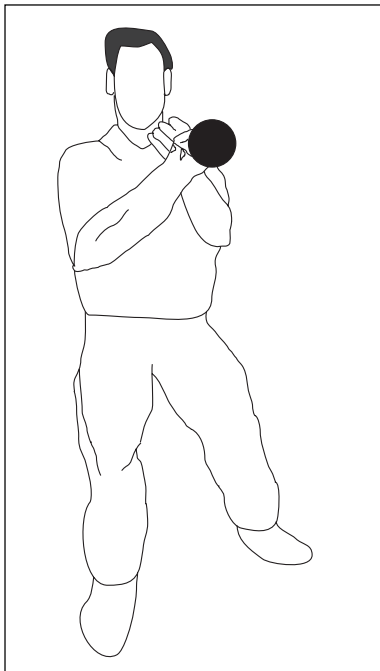

Fig. 56



Photo 86



Photo 87

Angle 8 - Diagonal low downward slash from left to right targeting opponent's forward thigh.





✎ Bloody Brazilian Knife Fighting' Techniques ✎

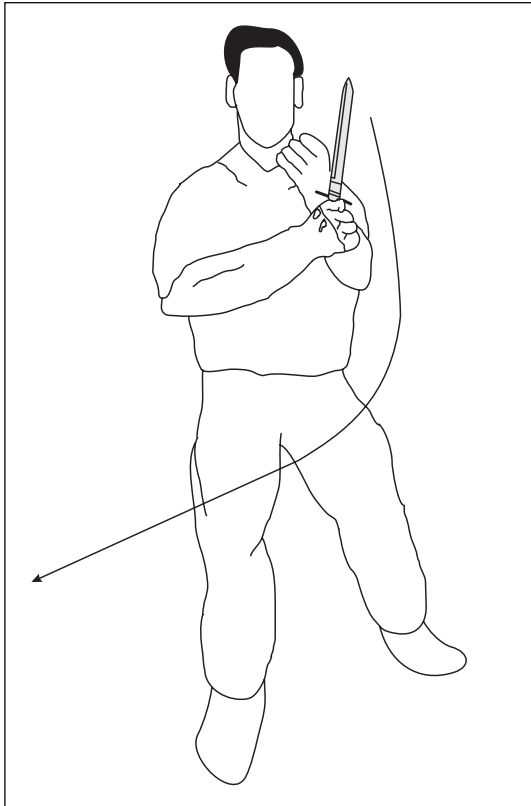

Fig. 57



Photo 88

Angle 9 - Diagonal low downward slash from right to left targeting opponent's forward thigh.

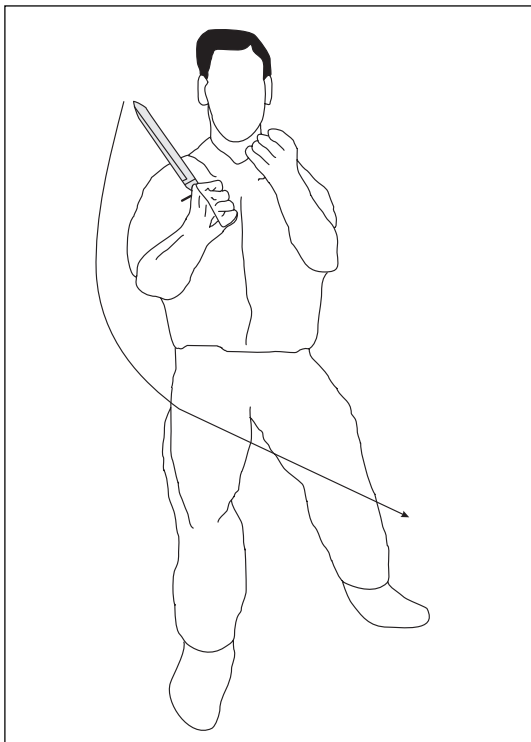

Fig. 58



Photo 89

Angle 10 - High straight thrust targeting opponent's right eye





✍ Bloody Brazilian Knife Fighting' Techniques ✍

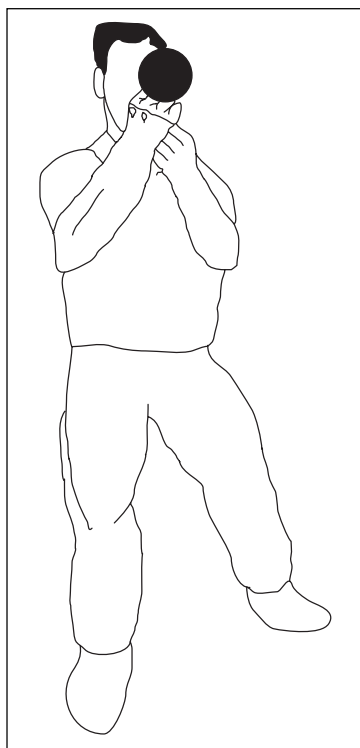

Fig. 59



Photo 90



Photo 91

Angle 11 - High straight thrust targeting opponent's left eye.

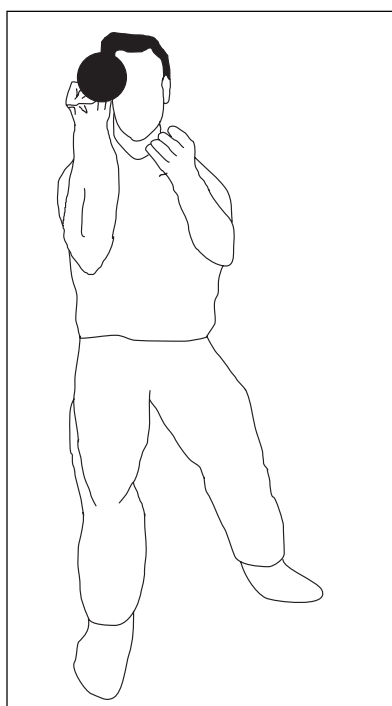

Fig. 60



Photo 92



Photo 93

Angle 12 - Straight downward slash from above head targeting opponent central line.



✎ Bloody Brazilian Knife Fighting' Techniques ✎

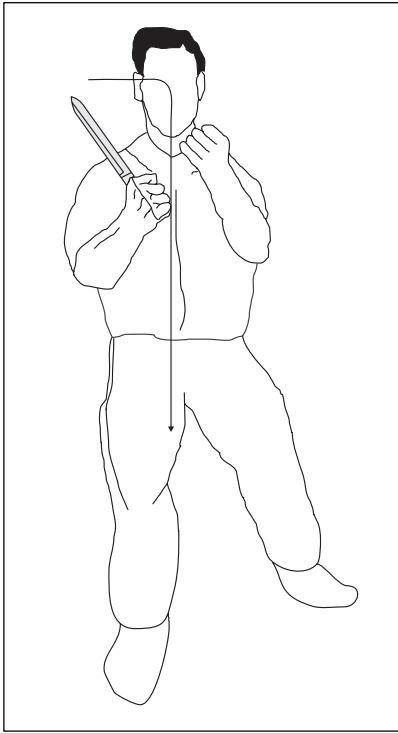

Fig. 61



Photo 94



Photo 95

After these attacks are flowing with ease you should do the same exercise together with footwork stepping in and out on each attack.

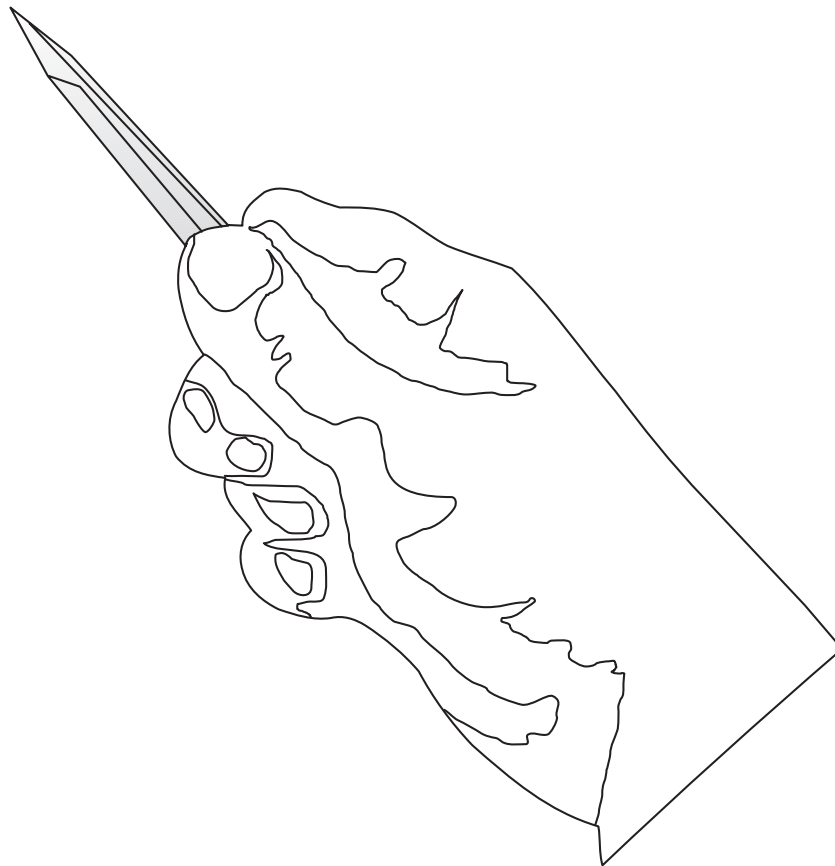

Fig. 62





Basic moves - combinations

Combinations will work on the flow of attacks and defense improving the technical skills of the fighter. The moves in combination work muscle memory making reactions more instinctive in a real combat.

First combination - Six defensive moves:



Photo 96 - High defense

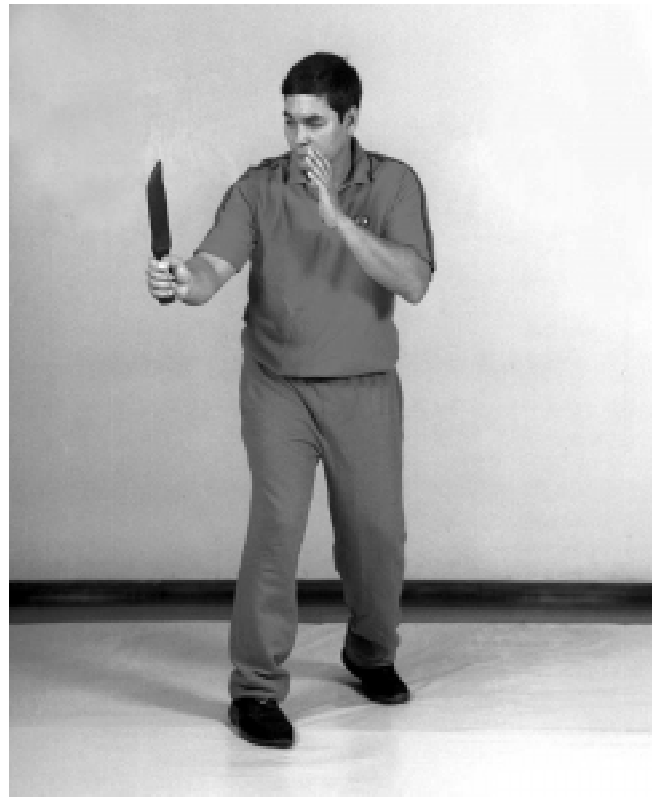

Photo 98 - Outside defense

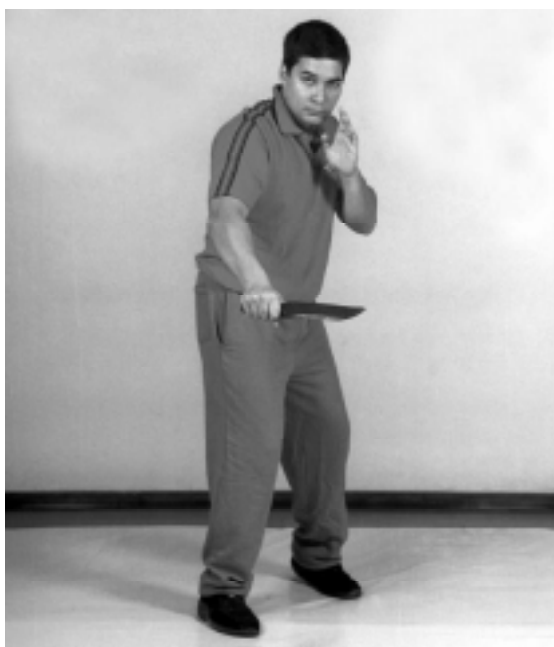

Photo 97 - Low defense

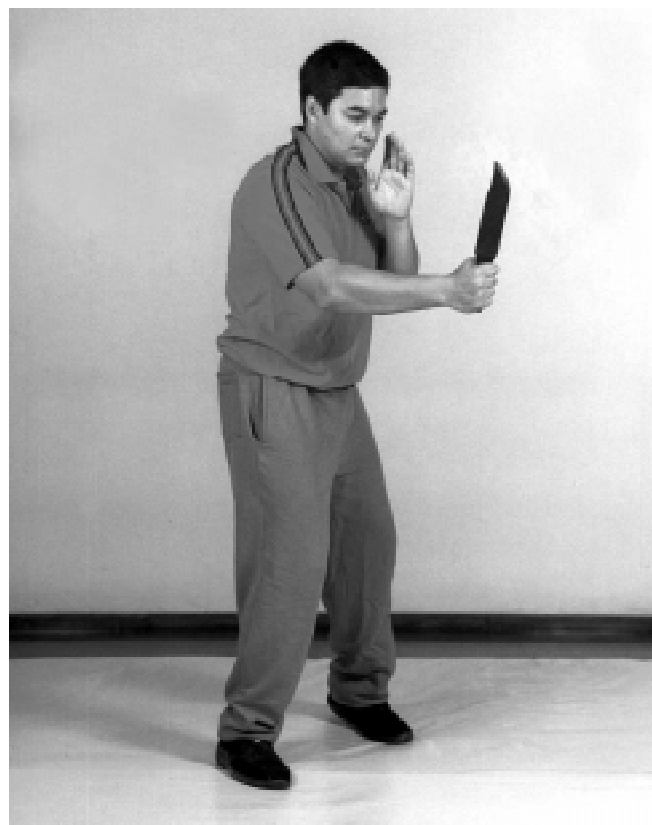

Photo 99 - Inside defense





✂ Bloody Brazilian Knife Fighting' Techniques ✂

Second Combination - Six attacks

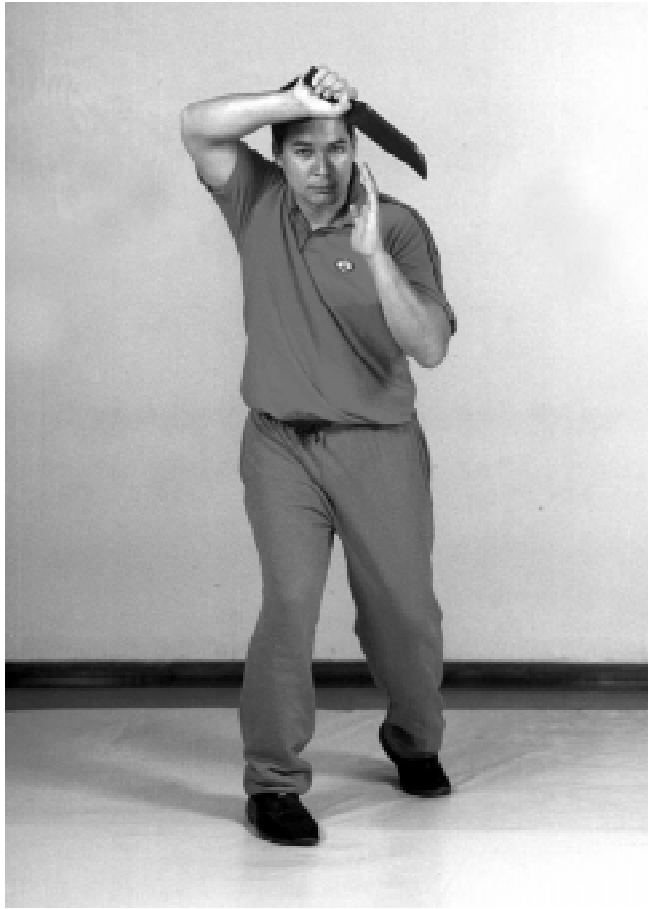

Photo 100 - Internal



Photo 102 - Slash angle 3 (to the neck)

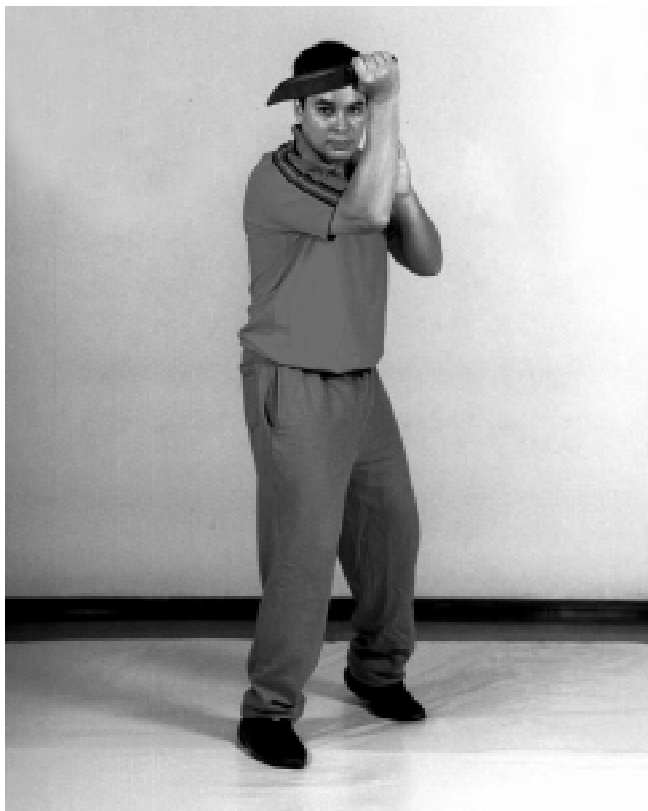

Photo 101 - External defence

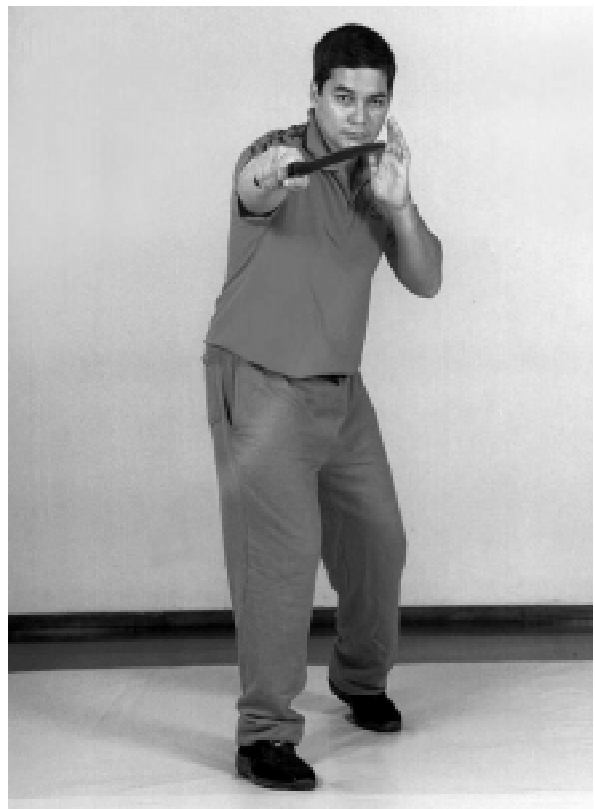

Photo 103 - Slash angle 4 (to the neck)



Bloody Brazilian Knife Fighting' Techniques

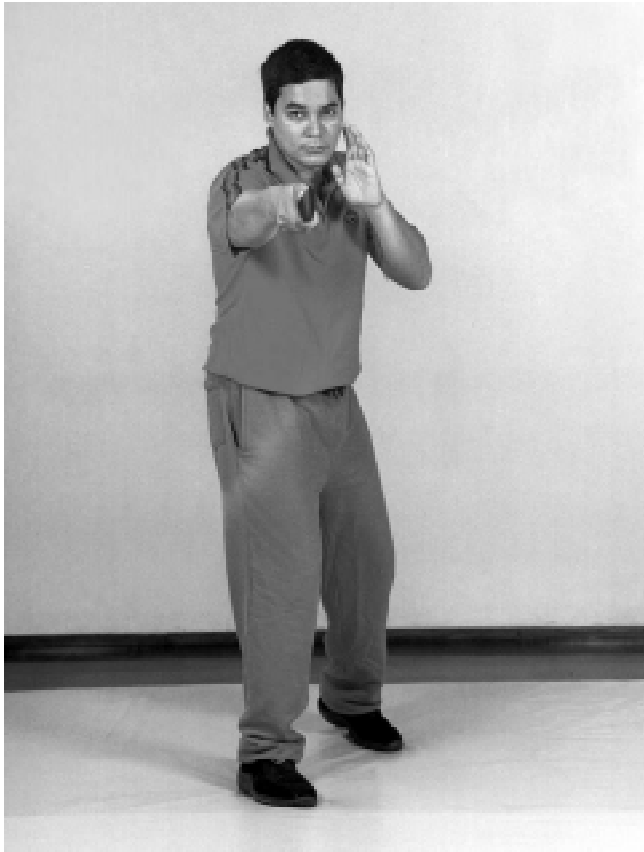

Photo 104 - Thrust angle 5 (to the neck)

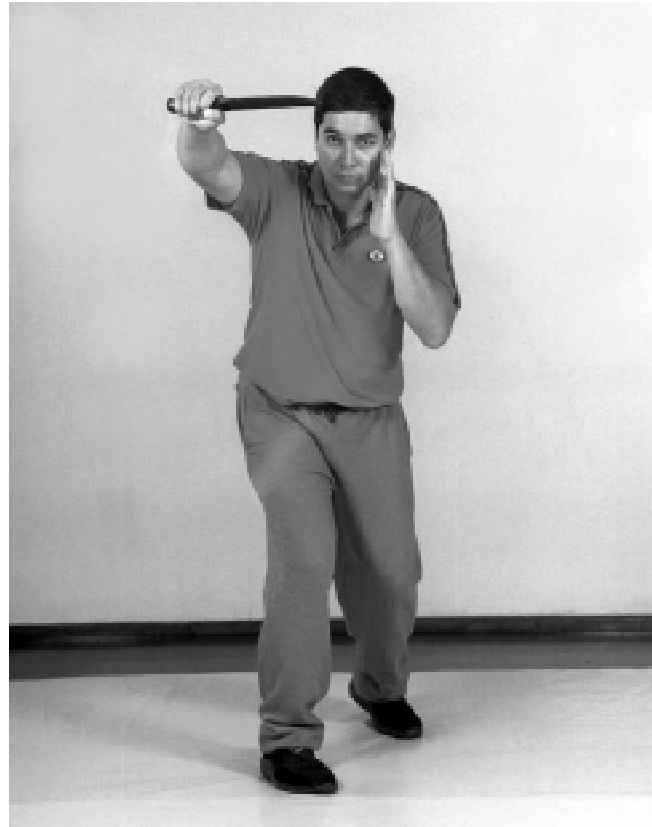

Photo 106 - Thrust to opponent's right temporal region



Photo 105 - Thrust to opponent's left temporal region

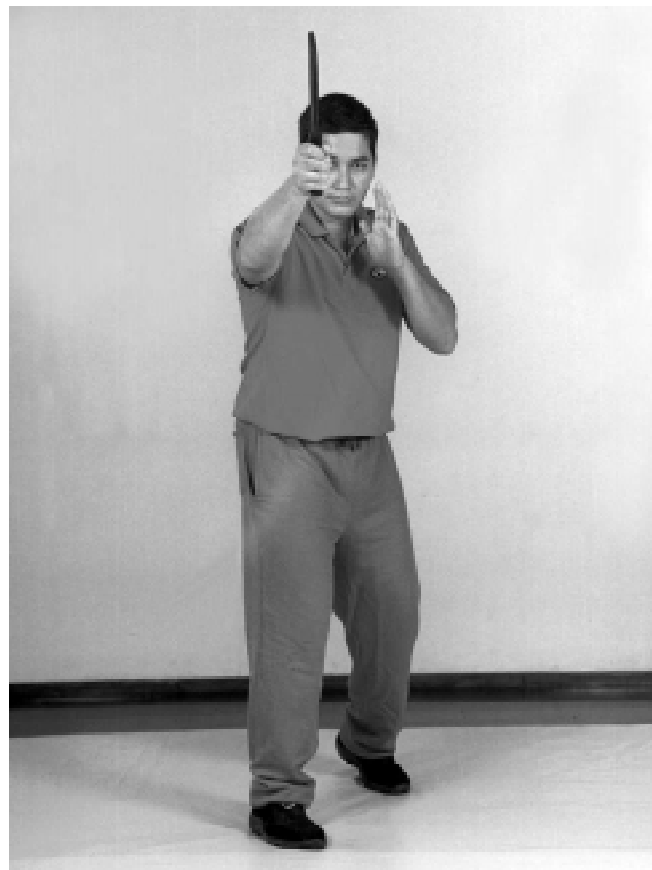

Photo 107 - Slash angle 12, right up the middle



Third-Combination Six Contusive Attacks



Photo 108 - Contusive attack to the chest

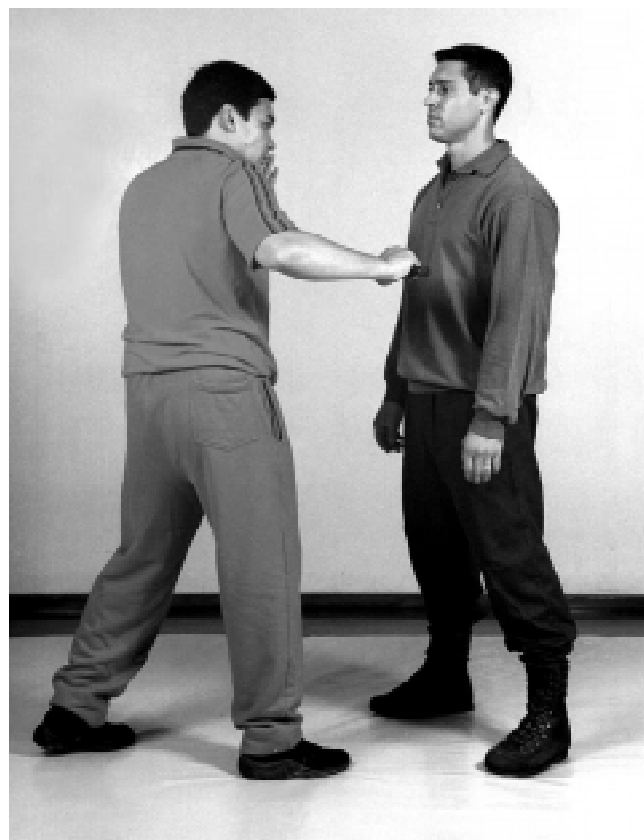

Photo 110 - Contusive attack to the left rib region



Photo 109 - Contusive attack to the nose

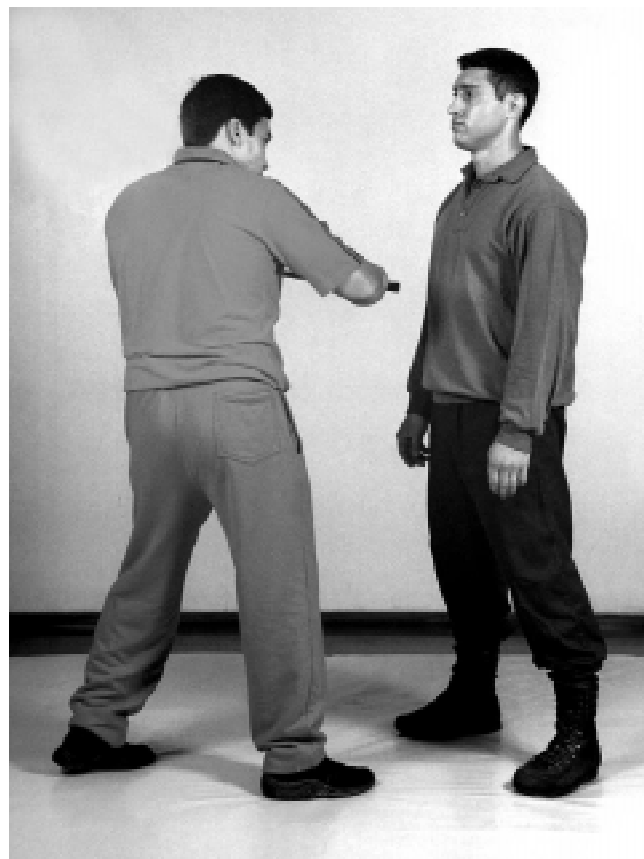

Photo 111 - Contusive attack to the right rib region



Photo 112 - Contusive attack to the testicles



Photo 113 - Contusive attack to the back of the head

Basic moves - working with a partner

It's important to work with a partner to get used to the distance and timing for attacking, to train blocks and passes, to train moves that could be used in a real combat and mainly to make clear the deficiency of your training. The most common shortcoming for most people will be that they 'telegraph' their attack. The basic exercises with a partner can be divided in to two types:

Simple drill:

This drill has a beginning, middle and end. We can work on attack, defenses and

counter-attacks. When we think about self defense we always analyse scenarios and find answers to them. This is an essential aspect when in a real dangerous situation, as it will lead us to instinctively react to it without much thought using techniques which are simple to do and can be remembered easily. This way we will not lose precious time being confused and trying to decide what to do in order to save our lives. In our system we study knife use to defend ourselves not only against unarmed attackers who are stronger physically but also when they are armed with knives, sticks, guns, and in numbers. We also train for special use by the military and security organizations.



Simple sequence against fire arm attack:



Photo 114



Photo 115



Photo 116

Photo 114 - The aggressor threatens with a gun. Observe that the victim has a concealed knife in his hand.

Photo 115 - We deflect the gun holding it and counter-attack with the knife.

Photo 116 - Still keeping the control over the gun we finish with a thrust against his trachea.

Exercise to improve muscle memory - This exercise strives to decrease the time in between thinking and reacting by working on the muscle memory to defend against possible knife attack.



Photo 117 - Defending low

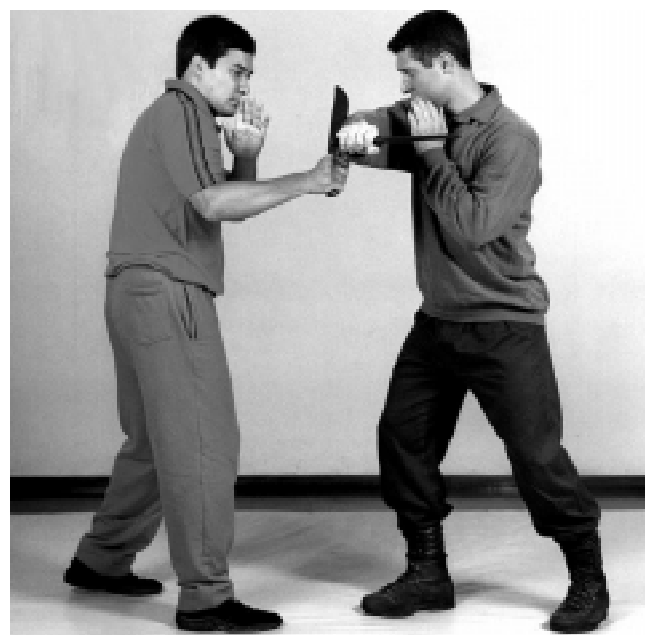

Photo 118 - Defending outside



Observation - Note that both practioners are using the knife. On this exercise one should use any of the moves as shown in the previous chapter without following any logical order to make the defensive response more difficult. This better prepares the fighter for any attack.

Attack and Defense Sequence

This is a fundamental exercise to improve and condition muscle memory to defend and counter attack. It has to start slow incre-asing the speed gradually. It is a good idea to train with different partners to get diffe-rent variations of attacks and to become bet-ter prepared for dealing with any attacker, no matter his/ her physical characteristics.

We should start using training knives to avoid injuries, and then progress to real kni-ves as this will improve the overall training. One has to be prepared to face a real knife in a real scenario. By training with real kni-ves we prepare ourselves psychologically for combat. We also should undstand this exercise as an emotional preparation percei-ving it as a real combat where our lives are in danger. Just giving it a good try is not enough. One must succeed.

Description

B attacks the right eye. A defends (photo 119)

A prepares to counter-attack (photo 120)

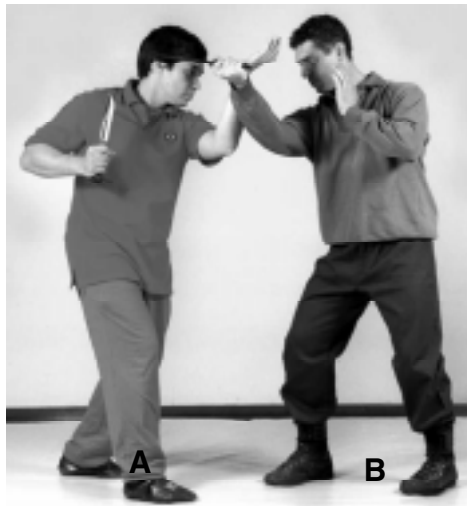

Photo 119



Photo 120

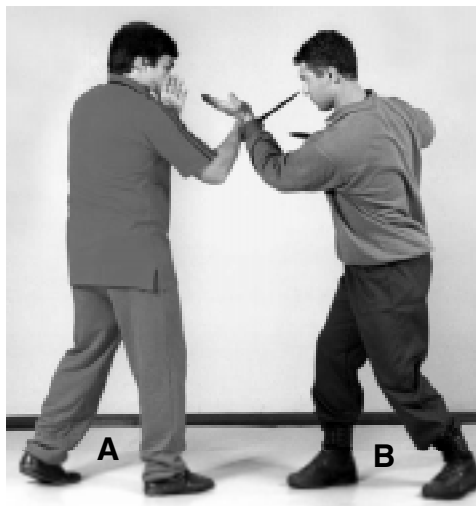

Photo 121

This drill is also named a continuous se-quence as it flows without a defined end and it can be performed alternating the initial atta-cker.



Control Drill:

As its name suggests, its goal is to control the aggressor using the knife to immobilize him/ her. We do not use lethal attacks. Instead we use techniques to break his attacking will.

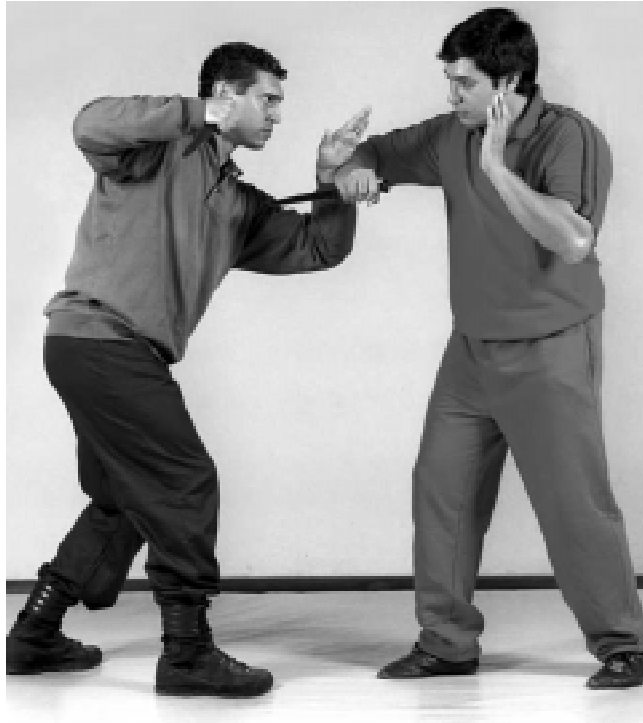

Photo 122 - The opponent blocks your attack



Photo123 - You lock up his arm



Photo 124 - You block his weapon hand

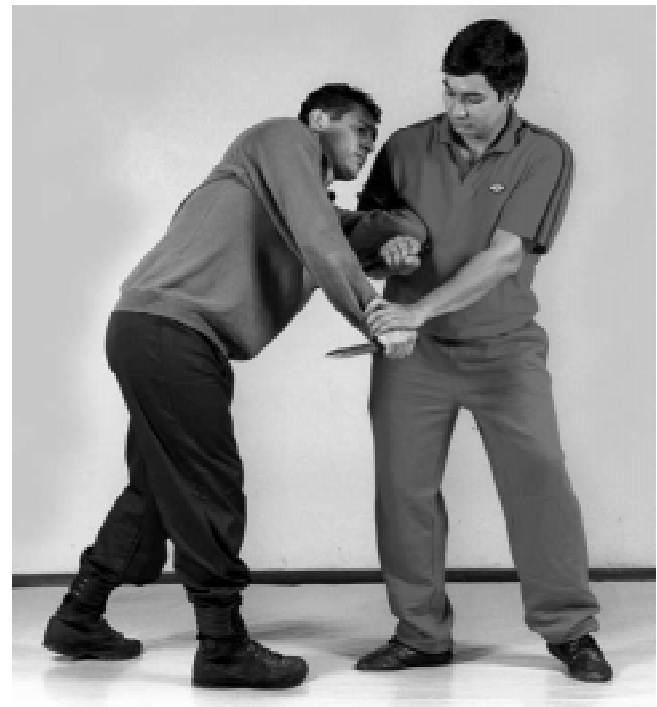

Photo 125 - You control his weapon using your knife

Releasing the knife hand

A common reaction for many fighters is to control the attacking knife hand. This technique has a few deficiencies: If not quickly followed by subsequent attacks the knife fighter will be able to attack with his free hand (Photo



✍ Bloody Brazilian Knife Fighting' Techniques ✍

126), knee (Photo127) or feet. When having your knife hand held is easy to release it by cutting his arm. This is done by twisting your wrist and arm.

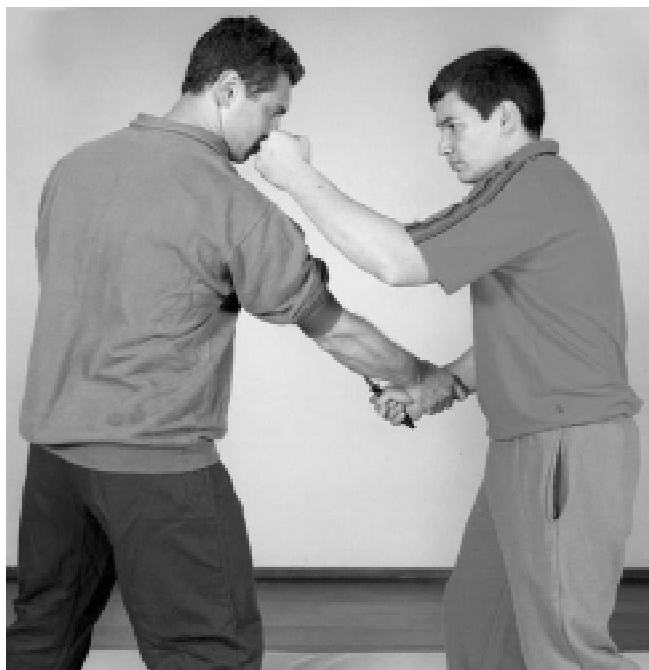

Photo 126



Photo 128 - The opponent controls your wrist

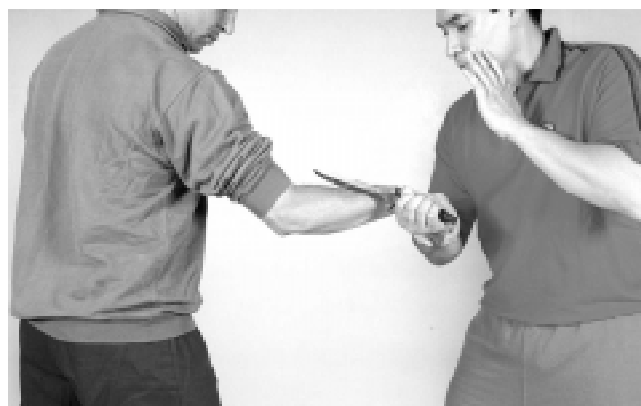

Photo 129 - Twist your wrist



Photo 127

This is done by twisting your wrist and arm.



Photo 130 - Twist your wrist inward

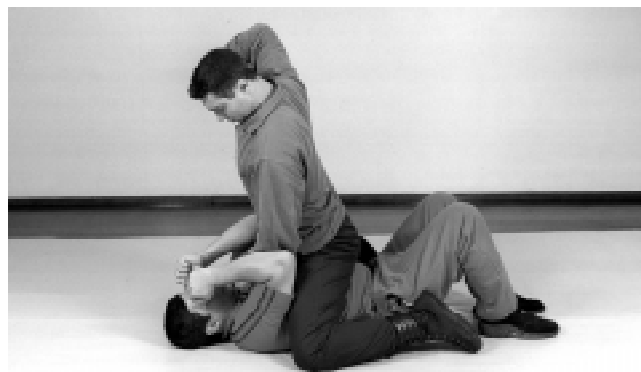

Photo 131 - The attacker takes you down



Photo 132 - With a knee blow you take him out of balance and it's time to reach the knife



Photo 133 - By uplifting your waist sideways you turn him down and counter-attack with the knife

12 Common errors

Keeping the knife still - One of the most common errors of beginners is to keep the knife forward and still in the air making it easier for the opponent to attack the knife arm or grab it.



Photo 134

To lower the guard - A low guard allows the opponent to attack with ease lethal targets therefore one should always keep it high.

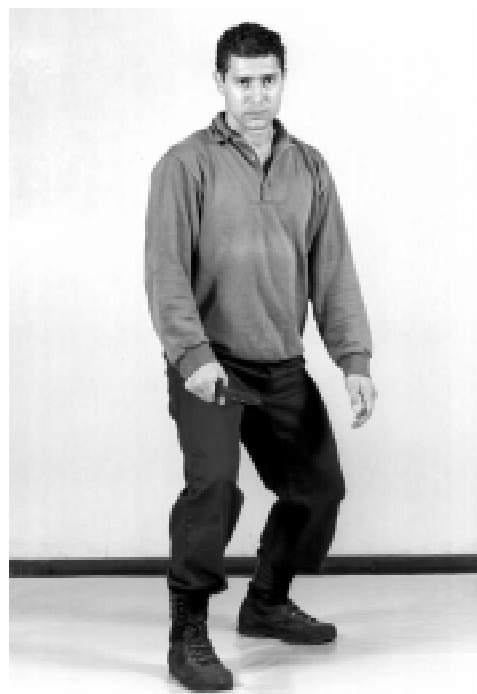

Photo 135

To telegraph the attack - any attack should start from the basic stance without demonstrating any preparation beforehand as it will give clues of your intention.

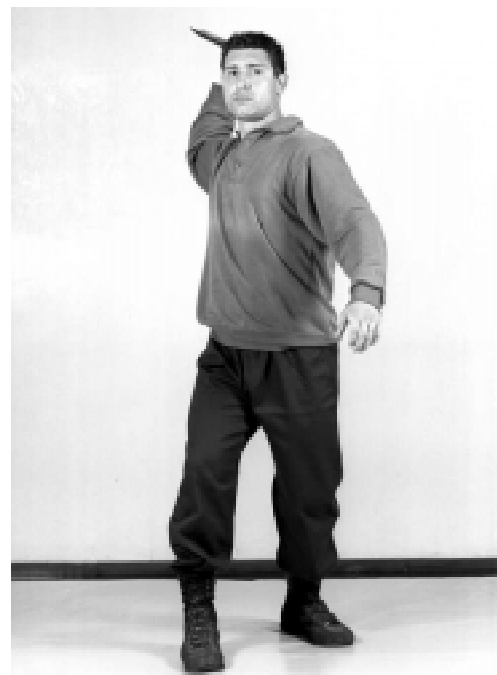

Photo 136



Inappropriate base - a wide base or a base with your weight on your back leg will decrease mobility and expose front leg for attacks (Photo 137). Photo 138



Photo 137



Photo 138

Poor Grip (Photo 139) - it makes an attack on the hand easier beside decreasing the potential power of attacks.

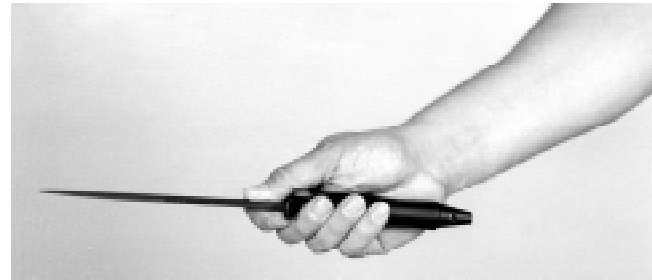

Photo 139

Stance with weapon Backward in a fight against a knife attacker - It allows an attack to the free hand.



Photo 140

Staring at the weapon - One should never keep all the focus of attention on the opponent's weapon.



Photo 141

Being tense during combat - By being tense the fighter will be slower. This will cause him problems in both defense and attack.





←  Bloody Brazilian Knife Fighting' Techniques  →



Photo 142



Photo 144

To thrust as an initial attack - Without a preliminary feint or other preparatory attacking move, thrusting facilitates the opponent's defense of the attack.



Photo 143

To attack the opponent's leg - when in the basic stance, it is going to be easier for the defender to counter-attack targeting a more lethal region of the attacker.



Photo 145

To hold the blade as a control maneuver - It is very easy to release the knife by cutting your hand to shreds.



Photo 146

To Substantiate your opponent can be lethal – every and any opponent can be threat to your life when using a knife. Even an apparently weak person can easily reach a vital organ very quickly putting an end to the fight and to your life.

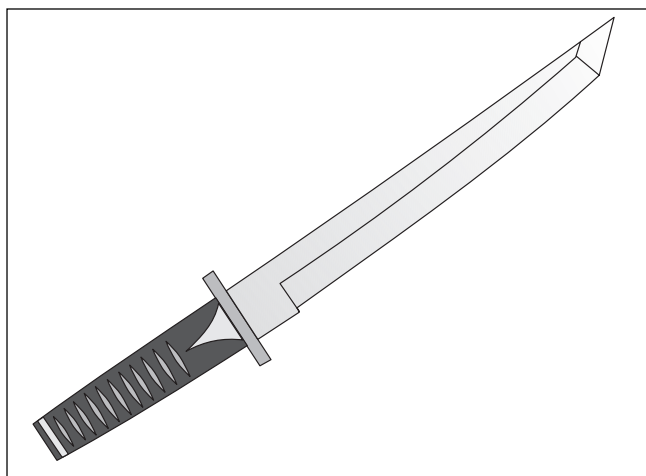

Figure 63

Defenses against knives

When confronted with a dangerous situation, usually the victim is paralyzed (even if just for a few seconds) due to the surprise factor. The Sotai System's goal is to prepare a fighter to be complete, with a broad view of combat. In order

to achieve that we provide training with weapons (firearms, edged, striking and improvised) and unarmed (standing, ground, tactical immobilizations, against weapons, etc).

In any system the most important knowledge is the preventive philosophy. We study the risks and avoid routine. We elaborate rules and procedures that will balance comfort with security and we prepare ourselves to react if necessary. One should know oneself and be able to control emotions. The techniques must be simple, fast and effective. The training must be continuous and one must be aware of the best moment for reaction.

The first rule of defense against knives is: Avoid it at all costs!! Try to escape, but if that is not possible be prepared for fighting. Be prepared to get cut and never to give up fighting.

Most people including experienced martial artists are simply not prepared for the realities of a knife fight, since this one of the worst of all scenarios.

One of the main reasons for that is the deficiencies and defects of most self defense training. Give knives the respect they command. Then by studying the use of the knife you will also learn the best ways of defending against it. Most defensive systems study only moves against a linear attack but it all gets messy when the attack is done differently, such as with different attack angles or with feints.

Many other objects, such as a tire iron, can be used with the same deadly consequences as a knife. During a combat situation, one must then take care to prevent such deadly weapons from falling into the hands of your opponent. If they are laying about, push the field of combat so they are away from his reach. Be wary of unknown weapons which the opponent may have hidden on his person.

Tactical options of defense

Prevention - Avoid unnecessary violence. The best defense is to be somewhere else.



Negotiate - To apologize will not kill you, the knife will.

Escape - Increasing the distance is essential to controlling the situation. Be miles away!!

Do not react - Study the attacker's intentions while avoiding unnecessary moves. A criminal might only want your money.

Keep you eyes open for improvised weapons - Many objects from your surroundings can be used as improvised weapons (umbrellas, belts, walking sticks, jackets, etc) and they help you to keep the distance or to immobilize the attacker.

If running away is not an option, attack first to take him by surprise. Be efficient!! Make a sequence of 5 or 6 devastating attacks. One attack only might be defended or controlled. A sequence will improve your chances of succeeding. Be sure to take him out!!

Shields: Its wise to use a shield in the front hand to stop an attack and counter attack. They can be improvised from jackets, trash-can lids, chairs, etc.

Defensive principles

Repetition - It is necessary to repeat the move as many times as necessary to really assimilate a technique. The move must become natural and the reaction instinctive and immediate.

Pain - One controls other by pain!! The bigger the pain the bigger the control. We can use pain to control, distract or to destroy his/her physical integrity.

Adaptation - It is not the opponent who adapts to the technique but the technique that is adapted to the opponent. To know the intricacies of the technique might be the difference between living and dying.

Changing - When a technique is not being effective, change to a different one. Be unpredictable and ready to overcome defenses.

Versatility - One technique for various situations and many techniques for one situation.

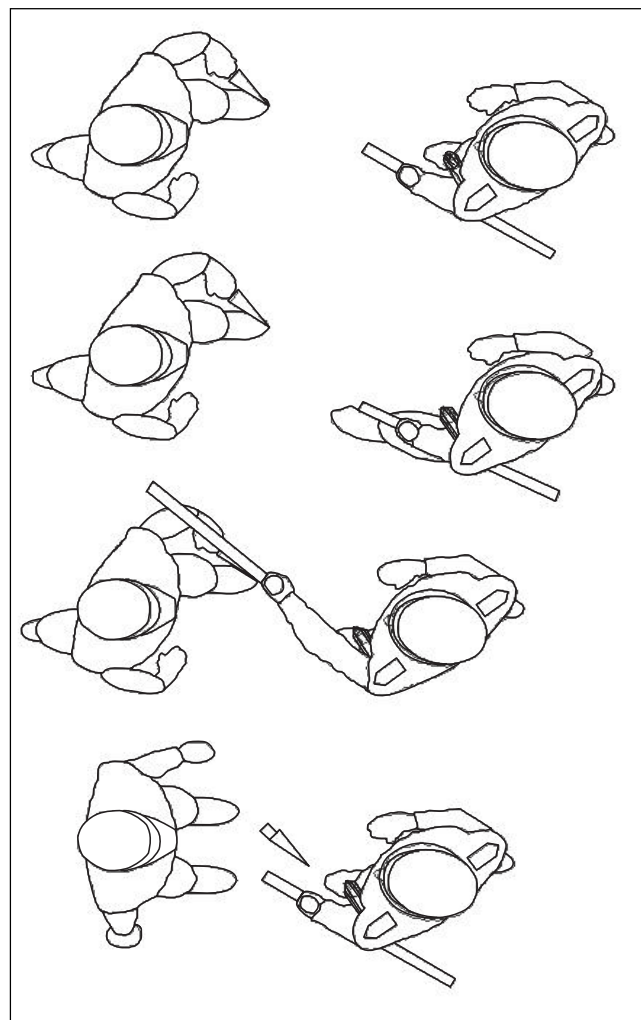

Figure 64 - A longer weapon, as a tonfa, provides a fighter with a longer reach giving him a great advantage over his opponent with a shorter weapon

Basic Defences

Attack low when the opponent attacks high. The timing must be correct (through a lot of training) and the move fast.

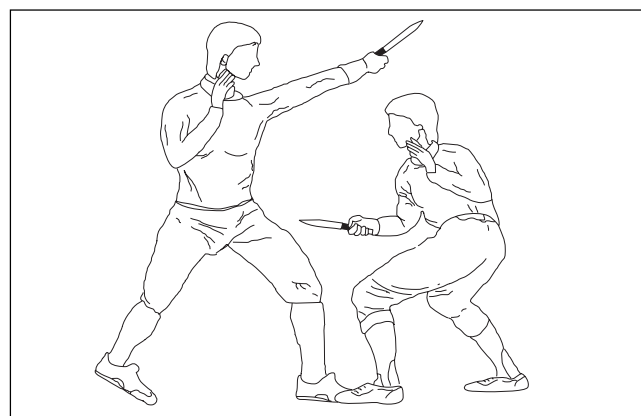

Figure 65



Counter-attack - It stops the flow of attacks making the attacker defend. The defensor stops being perceived as an "easy prey", because the best defense is a good offense.

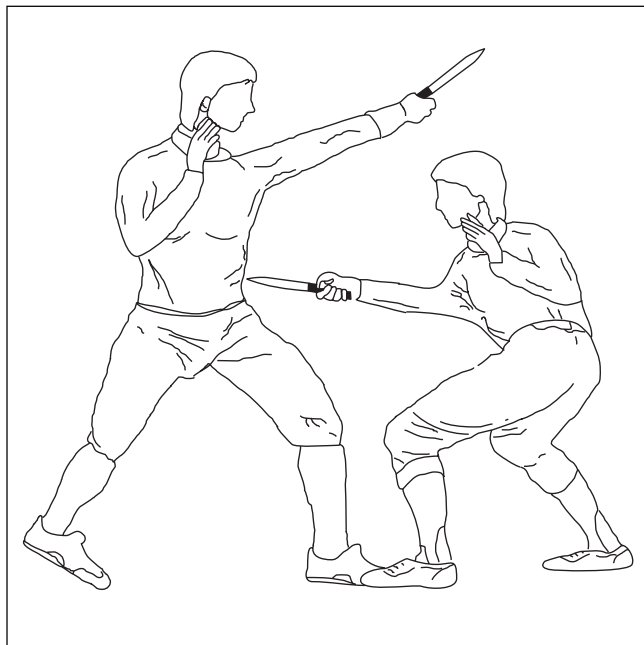

Figure 66

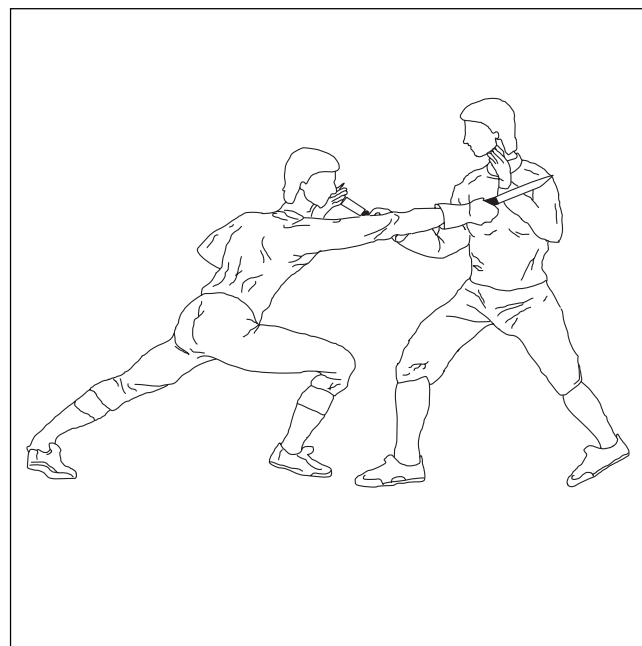

Figure 68

Blocks - The free hand can be used to block. This is an easy move to learn.

Retreat - Is is an useful move, but it doesn't stop the attacker from continuing the assault.

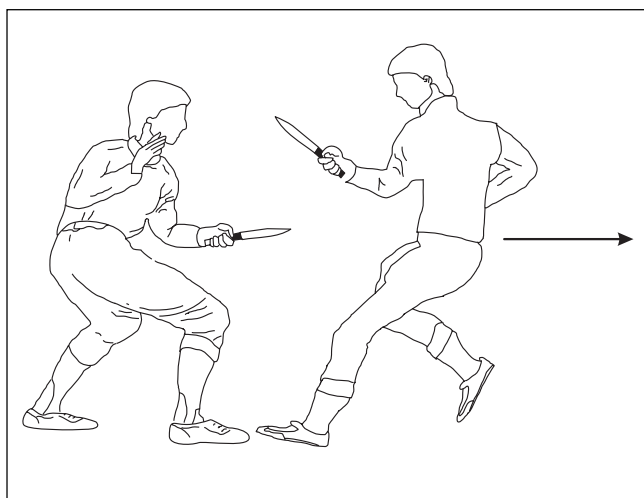

Figure 67

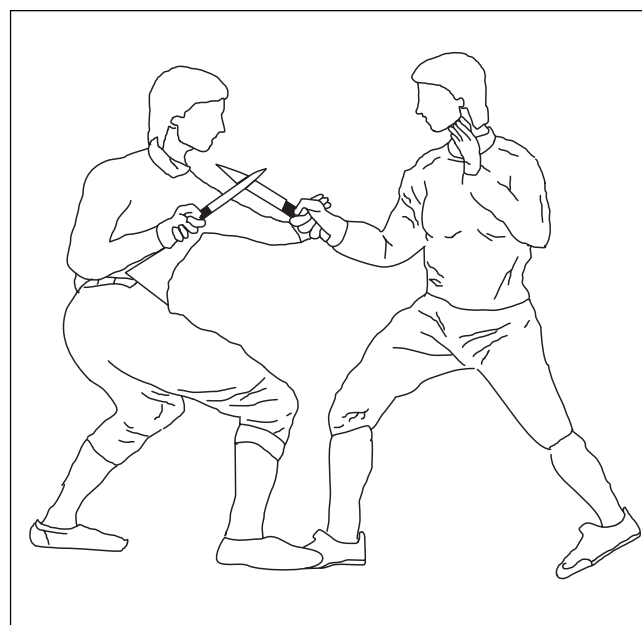
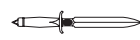
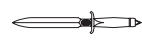

Figure 69

Evasion - To move sideways breaking with the linear sequence os attacks facilitates counter-attacks.

Avoid the X block, because the attacker can draw the knife back, cutting both arms counter-attgacks.



←  Bloody Brazilian Knife Fighting' Techniques  →

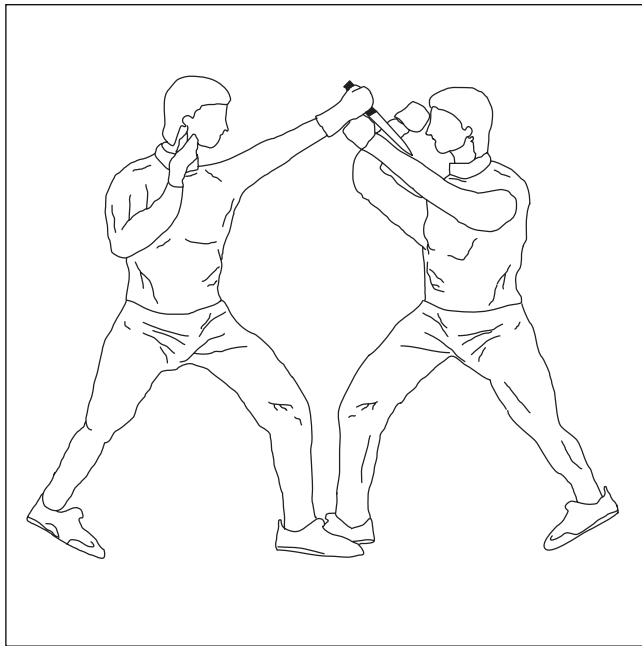

Figure 70

Increase distance - By using longer reach weapons (sticks, etc) you will be able to keep a safe distance.

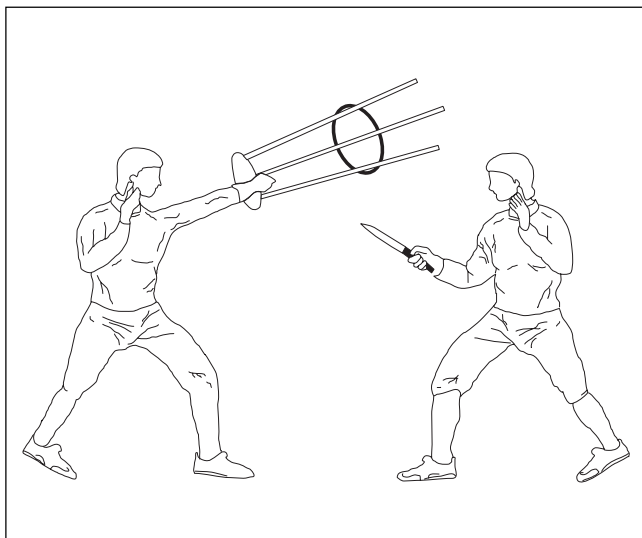

Figure 71

Barriers - Car, furniture, etc. can be used to keep a safe distance. Being far from the attacker is your best chance of surviving.

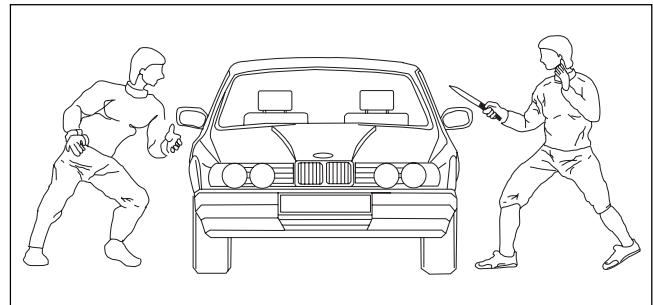

Figure 72

Firearms - Even when having a firearm, the attacker should not be allowed closer than 7 yards.

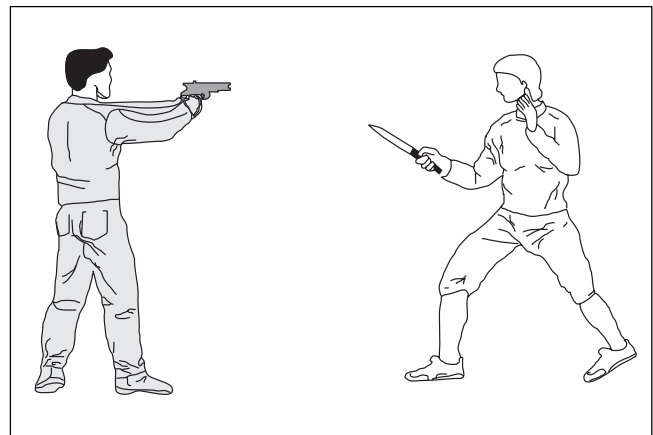

Figure 73

To run away is not a coward's measure when knowledgeable of our limitations. A knife attacker always has a big advantage in combat.

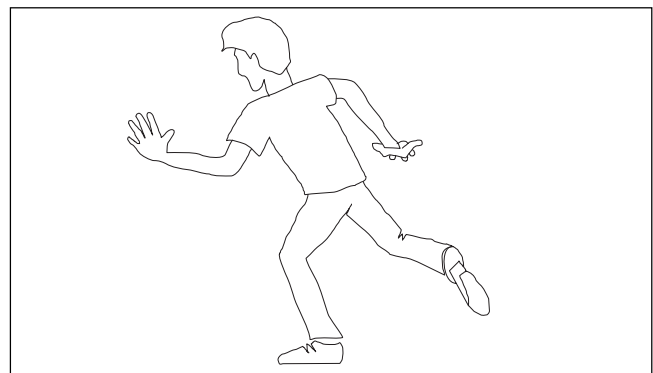

Figure 74



Bloody Brazilian Knife Fighting' Techniques



Rick "Kamikaze" Nakayama was born in Brazil, and is married, with one son who is following the father's steps. Master "Kamikaze" Nakayama created and developed today's most sought-after personal defense & knife fighting system: **SOTAI SYSTEM**. Brazilian SOTAI SYSTEM is a very advanced and revolutionary method, whose main characteristics are the extreme efficiency and simplicity of the techniques, along the utmost care for the preservation of the practitioners well-being. We can say that SOTAI SYSTEM is the most vicious, brutal and ruthless fighting system to one's foes, and a very secure one and friendly to its students. He started his training before he was 5 years old, under the wise guidance of his father and first Karate Master: worldwide renowned **Sensei Nakayama**, deceased. (Sensei Nakayama, Sr., moved from Japan to Brazil to teach Karate, a mission he accomplished with honour). For more than 30 years, Master Rick "Kamikaze" Nakayama honored his earlier teachings, pursuing a lifelong search for the ultimate Martial Art; he learned and earned Grades in such diverse Martial Arts, Contact Sports and Combat Techniques as Arnis de Mano, Kick Boxing, Hapkido, Karatê, Krav-Magá, Muay Thai, Jiu-Jitsu, Brazilian Jujitsu, Vale-Tudo, Kombato, Aikido, Capoeira, Occidental and Oriental Boxing, Judô and Kung Fu, besides being a Combat Handgun Master and teacher. Since 1982 he has taught at the most prestigious Dojos and Security Institutions (both Public and Private). His research on weapons combat started in 1978, when he started to learn the martial use of such traditional weapons as the Bo (long wooden stick), Chinese Short, Medium and Long Swords, Katana Sword, Balisong Knives, and the Nunchaku. At 22 years of age, he moved to Japan, where he earned his 2nd Dan in Karate, and there trained with several traditional Masters of different schools of Martial Arts, specially the Internal Arts, which were then very secret to the outsiders. After a 2-years period in Japan, Rick "Kamikaze" Nakayama moved to China, where he refined his skills on the Internal Arts like Tai-Chi, Chi-Kung, and Dim-Mak. Back in Brazil, he was the first Martial Arts Master to develop a systematized Knife Fighting System, uniting the raw realities of the Streets, with the coordinated methodology of the Oriental Dojo, along with a rational, simple approach, that incorporated unarmed defense skills with the Knife Fighting techniques. Since the early '80's, Rick "Kamikaze" Nakayama has taught unarmed self-defense, Knife Fighting, Tonfa and ASP (Baton) police techniques, as well as a very effective, street-proven, improvised weapons combat system using common items. For about 10 years, he was the technical manager of Latin America's largest private security institution, where he taught self-defense to more than 50.000 trainees. Besides being such a skilled Master on the Combat Arts, Rick "Kamikaze" Nakayama is also a Mathematics teacher, a Fighting Knives designer, and a very accomplished illustrator. He has a website: www.sotai.com.br, where internauts can see his techniques in photos and short movies.

Pedro "Fat" Cavalcanti is a Brazilian who started studying Judo at the age of 7 and who is now an accomplished master of this art. Pedro, however, has been in a constant search for the ultimate fighting system, so he also studied Kendo, Boxing, and the "Vale-Tudo" form of Brazilian Jujitsu. Pedro's interest in knives started while he served with the paratrooper branch of the Brazilian Armed Forces (Army). He knew a good thing when he saw it, and trained under Master Nakayama's direct supervision. He is today's most accomplished Brazilian student of this art, and is a Master Instructor. Pedro is now an advisor on threats management for radical sports and other high risk outdoors activities. His website is www.adventurefactory.com.br





Mad Abe – a.k.a. **J.R.R. Abrahão**, is a well known author in his native country of Brazil. He has over 60 published works, the most influential of which deal with the subjects of magic, sorcery, and the occult. Starting at Judo at the age of 4, under the worldwide renowned **Sensei Yamazaki**, and at Karate at 7, he graduated in these Arts. Besides these, he trained in several Martial Arts along the years, like Tae-Kwon-Do, Kung-Fu Wing-Chun, Tai-Chi, Chi-Kung, Occidental Boxing, Arnis, Fencing, Combat Hapkido, and Sotai System. He is also a Master at Pistol, Submachinegun, Shotgun, and Rifle. He now works as an attorney, but from 1980 to 1996 he battled the forces of Communism at home and abroad. He still does occasional “advisor” work in the fields in which he has expertise, specially terrorism, NBCR-warfare/MD-weapons, and armed combat. His spare time is spent with his favorite playthings. The 20,000 + rounds per year he fires from his machine gun and “destructive devices” collection would bankrupt a lesser man. When diversions with guns become tiring, he likes to light up a flame thrower. Special times are spent testing improvised fuel/air explosive devices (see *“Home Workshop Explosives”, 2nd. edition, by Uncle Fester*, to see some of his ideas on *FAM/FAE* devices). Mad Abe was also a VIP-BG to the Mayor of São Paulo city (largest South American city) in the late '80's, and also to other State VIP's. Retired from the operative field, he now serves the people by offering the world's largest free virtual library at www.alexandriavirtual.com.br



Uncle Fester – a.k.a. **Steve Preisler**, is the author of several books, and is generally recognized as the world's foremost clandestine chemist. His most influential works include *Secrets of Methamphetamine Manufacture*, *Home Workshop Explosives*, and *Silent Death*. Fester was an outstanding wrestler in high school and college, and when he saw the original Portuguese-language edition of this book he was fascinated and began to study and train. He became the first American student of this school of Brazilian knife fighting. He next undertook the English translation and rewrite of the original text. Fester is the father of two children, and he at present works a dayjob as an industrial chemist to support them in the style they are used to. When not working that dayjob or raising his children, he writes more books, researches the problems facing clandestine chemists, runs Festering Publications, and trains for marathons. His website is www.unclefesterbooks.com